

SKF Agri solutions

Achieve more with less



Contents

What our customers say about us	4	Seeding	38
Agri solutions overview		Application challenges	38
SKF Explorer range	6	Product tables by machine and position	
Application specific agricultural solutions	7	Disc opener	40
Bearing seals – range overview	8	Gauge wheel and press wheel/closing wheel	44
Bearing seals – performance overview	10	Seedmeter and seedmeter drive shaft	45
Agri Hub range overview	11	Harvesting	46
Tractors	12	Application challenges – Combine harvester	46
Application challenges	12	Application challenges – Disc mower	47
Preferred assortment – Tapered roller bearings		Application challenges – Baling	47
Tapered roller bearings – metric range	13	Product tables by machine and position	
Tapered roller bearings – inch range	17	Combine harvester – Head	48
Tapered roller bearings – matched	18	Combine harvester – Feederhouse/Rotor	49
Preferred assortment – Seals		Combine harvester – Clean Grain/Residue	50
Seals – metric range	19	Disc mower – Disc/blade	54
Seals – inch range	21	Baling – Pick-up	55
Application specific offers		Baling – Round baler	56
Tapered roller bearings	25	Baling – Square baler	58
SKF Mudblock seals	25	Attachments and trailer wheels	59
Tillage	26	Application challenges	59
Application challenges – Primary tillage	26	Product tables by machine and position	
Application challenges – Secondary tillage	27	Implement wheel and walking beam	60
Product tables by machine and position		Conversion Tables	62
Primary tillage – Disc plough	28		
Secondary tillage – Independent tillage disc	29		
Secondary tillage – Gang disc	32		
Secondary tillage – Seedbed finisher	35		

SKF, together with its brand PEER, provides solutions and products for equipment in all stages of the crop cycle.

With a full standard assortment from SKF and complementary, customer-specific solutions from PEER, you can achieve high reliability, at low ownership and operating costs. You can get global availability and a best-in-class bearing logistic network, enabling you to acquire any spare part and have it shipped to wherever you are located.

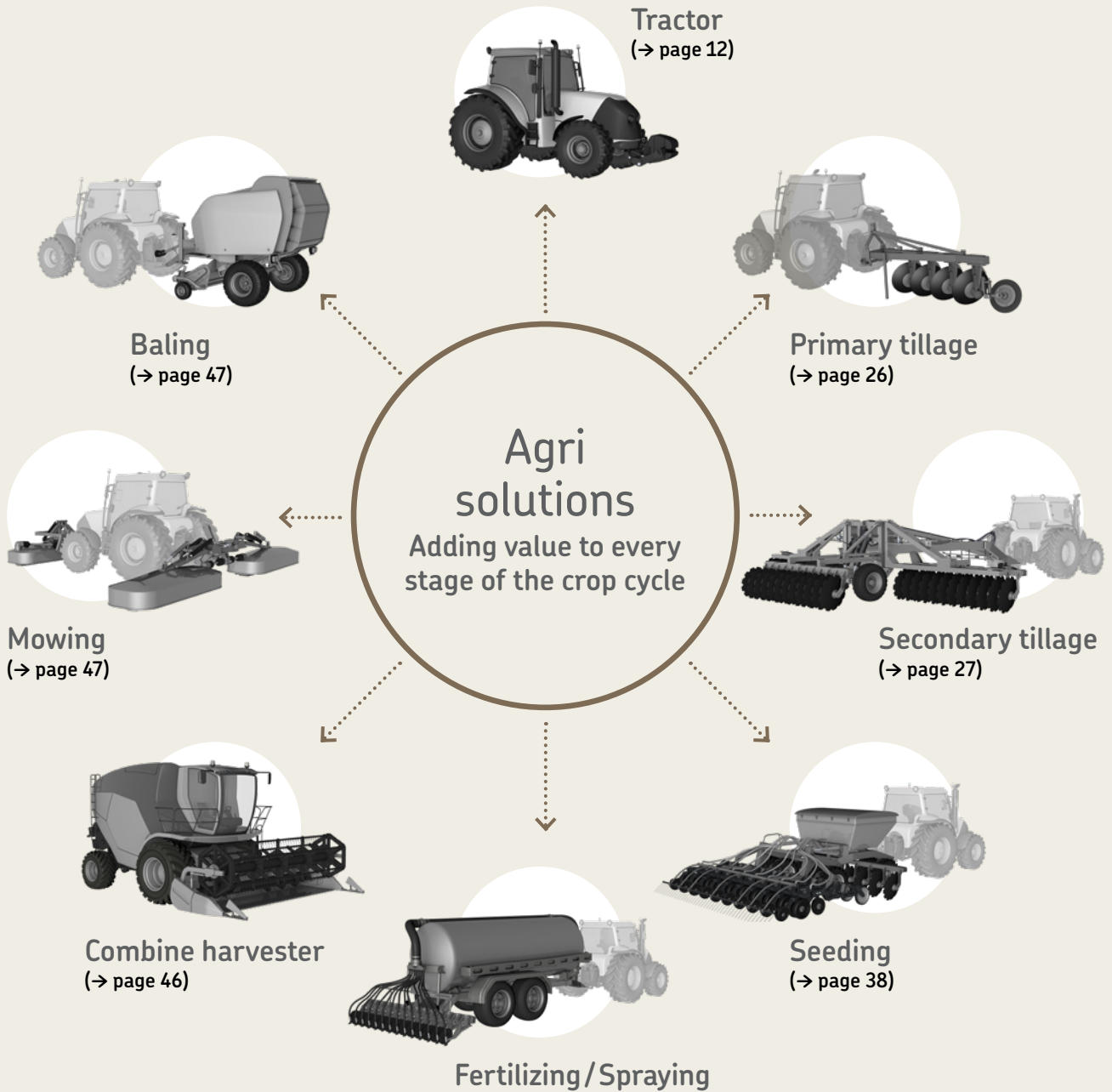

What our customers say about us

Agri hubs and units for tillage



"My farm requires 40 days tillage a year – 30 in spring to prepare for the maize and 10 in autumn to prepare for the wheat. With the SKF Agri Hub there is no need to wash and lubricate the discs and I save half an hour a day. The work is done more quickly and easily. We drive at more than 20 km/h and I have seen an improvement in the way the land is worked: with the old harrow the top speed was 7 or 8 km/h. The old 2.5 metre harrow worked one hectare an hour, the new machine, which is still 2.5 metres covers two and half hectares an hour. The old 20 disc harrow required a 20 kilo can of grease each year. With this new solution, I've eliminated greasing and washing. In my job I'm in contact with nature every day and I'm pleased that with the SKF solution I'm not polluting the land with grease anymore."

During testing:

"We've pulled our Norwood Kwik-Till machine 11–12 mph through the field and so far have covered 8 000 acres with zero bearing failures. That is truly exceptional!"

Dan Norwood
President, Norwood Sales Inc., USA

"After one season in Russia, the PEER gang disc unit performs more than two times better than the previous grease relube solution."

Luca Rigon
Engineering Manager Tillage Equipment,
Maschio Gaspardo

"The PEER bearing unit passed two tillage seasons in the rolling basket application without any failures and performed way better than the previous solution."

Cyril Thirouin
Engineering Director, Gregoire Besson,
Rabe, Agriway

Cooperation

“The machines are becoming more and more complicated so we have to improve the material that we use and systems that make these machines easy to use for the operators, otherwise it is difficult to be successful. Normally, in the past years, the suppliers were giving us just components. But, today they have to work with us to identify and supply complete systems to integrate into our machines and develop together with our engineers to be more and more interesting for the market. So we need strong cooperation with experts and suppliers to solve the problems of each single system.

In this case, SKF can help us to complete our machines with high-quality and cost effective solutions.”

Gianfranco Donadon
Technical director, R&D,
Maschio Gaspardo

“We are constantly looking to customer needs. For those customer needs, we go to engineering who help us develop new products that cope with these requirements. Customers don't like downtime, and maintenance is a kind of downtime. So they try to reduce that as much as possible. That's why we want suppliers like SKF, who will reduce our customers' downtime.”

Marcel Verhoeven
Combine Harvester Product Manager,
New Holland

“We have been designing and building corn harvesting machines for over sixty years. Customers are looking for increasingly advanced machines able to improve production in less time and with higher quality. Olimac has focused most of its resources on technological research and innovation. This has enabled us to design and produce corn heads allowing for complete corn harvesting of every ear and kernel without any product loss. We buy bearings from SKF because SKF bearings are of high quality and high precision, superior to other suppliers. They contribute to long life and great performance in our products.”

Lorenzo Carboni
Research & Development Director,
Olimac s.r.l.

Bearings for harvesting, seeding and tillage

“SKF insert bearings are premium products that deliver premium performance. That's why we chose them in the first place, and why we don't ever intend to switch.”

Javier López
C.E.O.,
Industrias David, Spain

“We have seen a significant change in quality – for the better. Now we can harvest a whole season without replacing any bearings. It saves a lot of time when we are able to harvest without any downtime through the whole season. The 3-lip insert bearings have given us more reliability and savings in man-hours. I warmly recommend them.”

Ole Madsen
Owner of Kjargaarden farm
SKF bearings were purchased via Kramp
Denmark.

“The relubrication-free units supplied by PEER Bearing offer significantly improved bearing life over traditional bearings.”

Ben Covell
Product Development Manager,
Simba Great Plains

SKF Explorer range

Recommended for tractors



SKF Explorer rolling bearings accommodate higher load levels and provide extended service life.

Optimized internal geometry reduces friction, wear and heat generation, allowing heavier loads to be accommodated.

Their advanced surface finish reduces friction and enhances lubricating conditions.

Diagram 1

SKF Explorer design

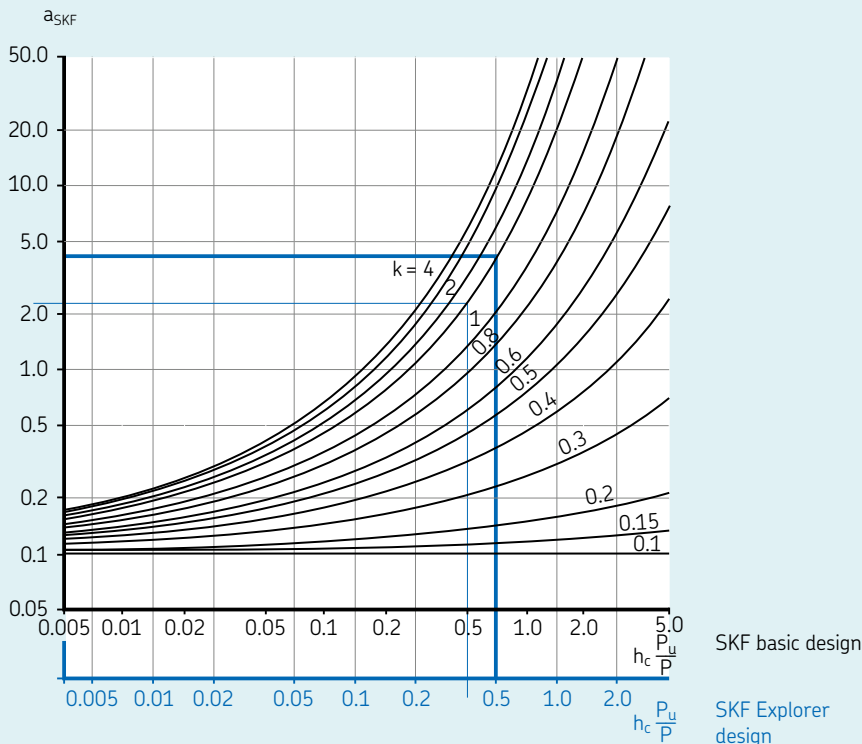

* The factor a_{SKF} represents the relationship between the fatigue load limit ratio (P_u/P), the lubrication condition (viscosity ratio k) and the contamination level in the bearing (h_c).

Example: SKF Explorer tapered roller bearings – get more uptime all the time

- Robustness
- Wear resistance
- Reliable in operation
- Long service intervals
- Contamination resistance
- Additional options include case hardened bearings and coatings

- Double service life of application under tough conditions
- Up to 23% increased dynamic load ratings

Application specific agricultural solutions

Recommended for agricultural attachments

Proven through years of research, development and rigorous testing in both the lab and field, the advanced sealing technology can significantly increase performance for the customer.

The application specific agricultural products offer a high-performance solution designed to reduce the need for relubrication, saving precious hours needed for field work. The seal design can provide significantly improved contamination exclusion than the conventional triple-lip seal design.

Application specific engineered assemblies can offer higher reliability, are relubrication-free and can simplify the installation. As an environmental friendly solution, grease purge to contaminate the soil can be avoided.



Diagram 2

Reduced total cost of ownership for farmers

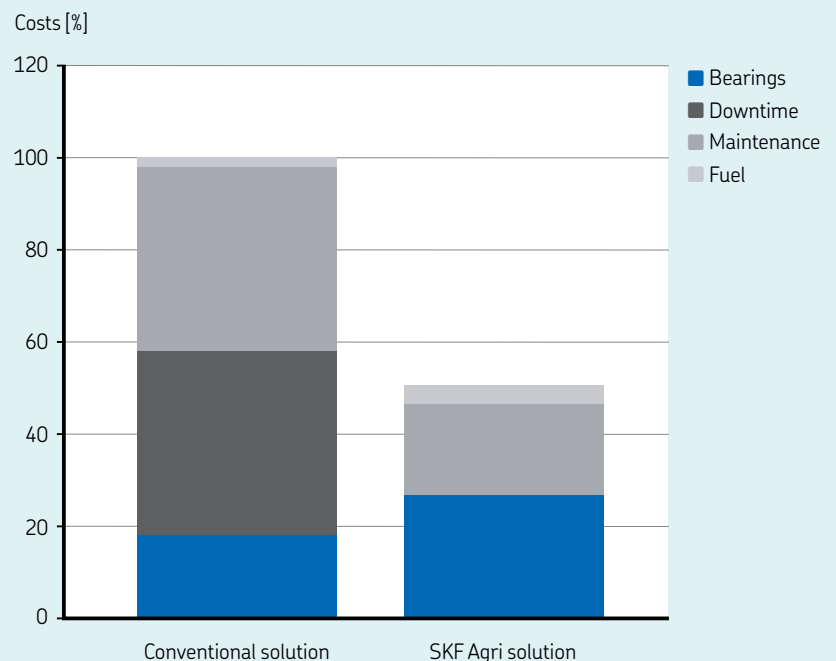





All figures and graphs are rounded off and based on SKF testing estimates.

Bearing seals – range overview

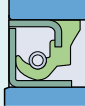
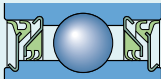
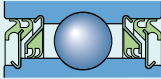
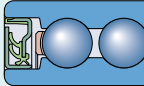
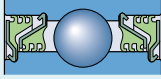
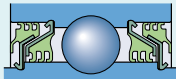
Seal type	Abbreviation in product tables	Seal cross section	Application max. speed (r/min)
Single lip	1-lip R 1-lip RST		4 000
Single lip	1-lip RS1		4 000
Single lip	1-lip RSH		4 000
Single lip with flinger	1-lip 2F		4 000
Single lip	1-lip F		4 000
Single lip	1-lip G		4 000
Single lip with rubberized flinger	1-lip RF		2 000
2-lip	2-lip		2 000
3-lip high speed	3-lip HS		1 000
3-lip low speed	3-lip LS		600

According to application and typical environment, recommended seal design differs. Our application engineers help you and develop new product and seal designs before mud slurry testing and field tests can validate the product.

Seal type	Abbreviation in product tables	Seal cross section	Application max. speed (r/min)
Cassette seal	CS		3 500
4-lip	4-lip		400
5-lip	5-lip		400
SKF Mudblock for seeding	MS		400
6-lip	6-lip		300
7-lip	7-lip		300
Double cassette seal	DS		300
SKF Mudblock	MB		300
SKF Mudblock + Cassette seal	MC		300

Bearing seals – performance overview

Diagram 3

Seal performance in mudslurry test

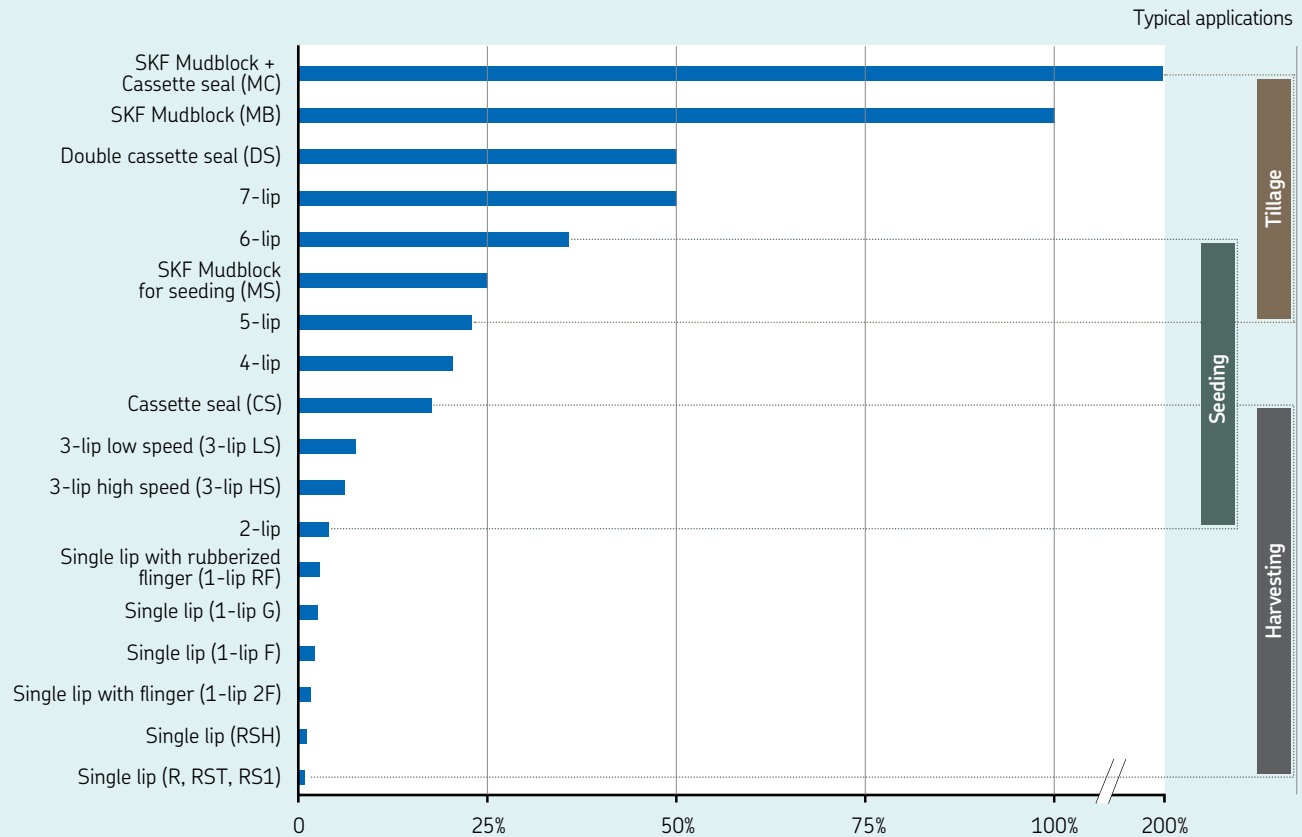

All figures and graphs are rounded off and based on SKF testing estimates.
Source: Lab test and customer field experience since 1997



Mudslurry test rig

Agri Hub range overview

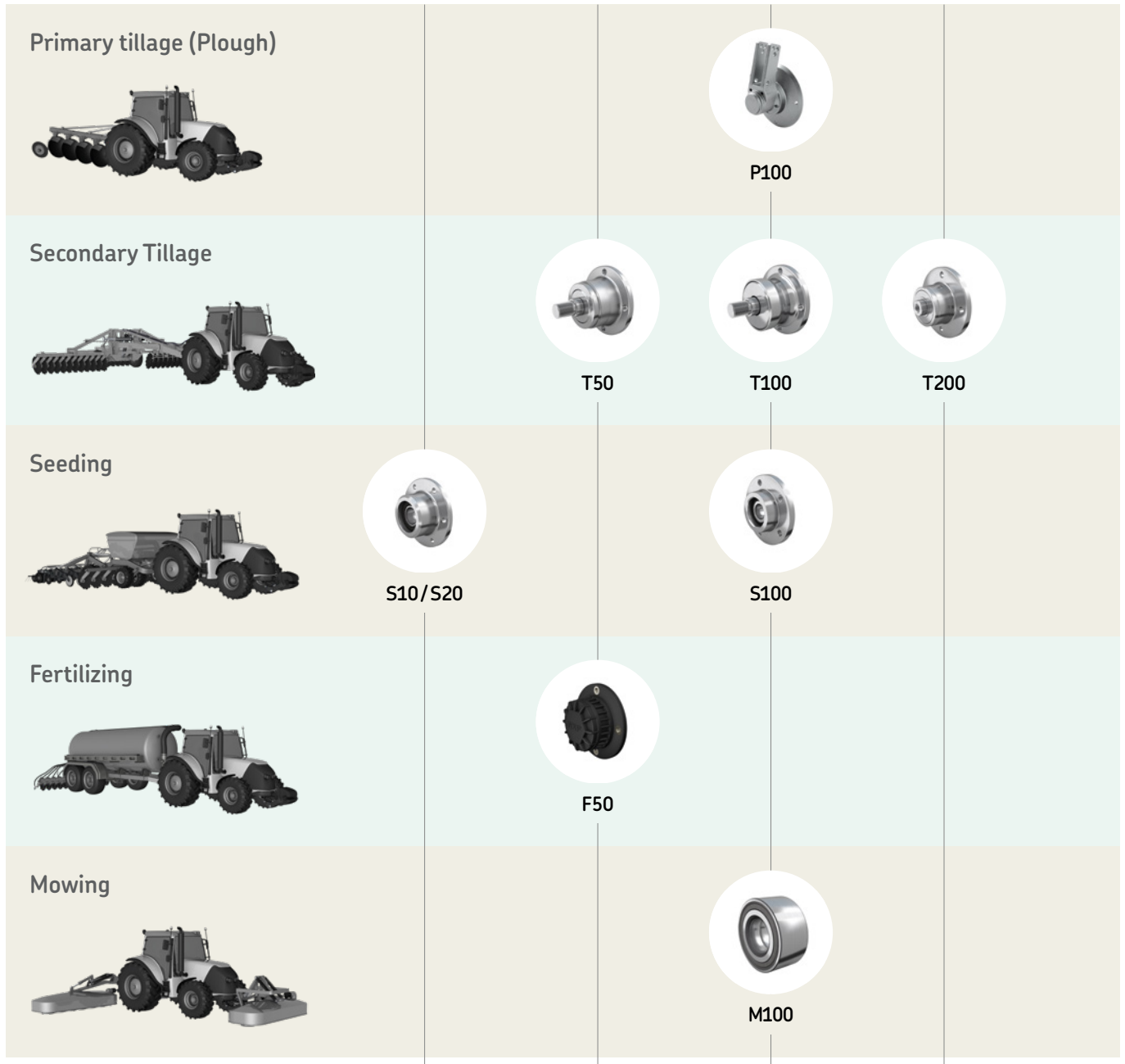

		10 000	50 000	100 000	200 000
Optimal conditions	hectares	10 000	50 000	100 000	200 000
	acres	25 000	120 000	250 000	500 000
Heavy conditions (harsh, abrasive, wet and muddy)	hectares	1 000	5 000	10 000	20 000
	acres	2 500	12 000	25 000	50 000

All figures and graphs are rounded off and based on optimal conditions, acc. to SKF testing estimates.

Tractors

Agricultural tractors are the work horses of the industry with drivetrain, engine, suspension and steering being key sub-systems. Safety, availability and productivity are the underlying forces driving many of the industry trends, such as:

- Automation, smart functionality and power management
- Better efficiency which reduces frictional losses, resulting in lower fuel costs
- Increased power density and reliability
- Standardization (consolidation of the powertrain)
- Improved comfort and safety



Application challenges

On-road time and travelling between locations means time away from the field. Allowing higher on-road speeds whilst maintaining a compact tractor design with tighter turning circles can increase the portion of time that these assets are truly productive. Additional challenges are:

- Long, intensive work periods
- Exposure to the elements and harsh ground conditions
- Reducing grease consumption
- Increasing productivity, efficiency and profitability

If key components are not designed for these kinds of conditions, it can easily lead to damage and early life failure. Such events lower productivity, increase maintenance costs and reduce overall profitability.

Solutions for tractors

Among the many products especially developed to handle harsh conditions, SKF offers a wide range of SKF Explorer roller and ball bearings, plain bearings and bushings, geared hub units and seals.

For steering and suspension, reliance on grease lubrication increases the maintenance costs and also risks both crop contamination and disruption to the sensors that are increasingly a part of the digitalization of farming.

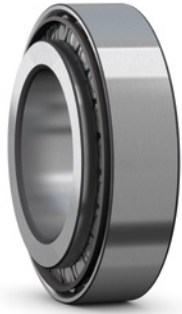

Designation	Dimensions			Basic load ratings		Fatigue load ratings	Speed ratings	
	Inner diameter	Outer diameter	Overall width	dynamic	static		Reference speed	Limiting speed
	d	D	B	C	C ₀	P _u		
–	mm			kN		kN	r/min	
32005 X/Q ¹⁾	25	47	15,00	33,2	32,5	3,25	12 000	14 000
30205 J2/Q ¹⁾	25	52	16,25	38,1	33,5	3,45	11 000	13 000
32205 BJ2/Q ¹⁾	25	52	19,25	44,5	44,0	4,65	10 000	13 000
33205	25	52	22,00	57,9	56,0	6,00	10 000	13 000
30305	25	62	18,25	55,3	43,0	4,75	9 500	12 000
31305	25	62	18,25	46,6	40,0	4,40	8 500	11 000
32305	25	62	25,25	74,1	63,0	7,10	9 000	12 000
320/28 X	28	52	16,00	39,0	38,0	4,00	10 000	13 000
322/28 B	28	58	20,25	51,9	50,0	5,50	9 500	12 000
302/28 J2	28	58	17,25	46,6	41,5	4,40	10 000	12 000
32006 X	30	55	17,00	43,9	44,0	4,55	10 000	12 000
30206	30	62	17,25	50,0	44,0	4,80	9 000	11 000
32206	30	62	21,25	61,8	57,0	6,30	9 000	11 000
33206	30	62	25,00	79,7	76,5	8,50	8 500	11 000
30306	30	72	20,75	69,2	56,0	6,40	8 000	10 000
31306	30	72	20,75	58,3	50,0	5,70	7 500	9 500
32306	30	72	28,75	95,0	85,0	9,65	7 500	10 000
320/32 X	32	58	17,00	45,1	46,5	4,80	9 000	11 000
32007 X	35	62	18,00	52,3	54,0	5,85	8 500	10 000
30207 J2/Q ¹⁾	35	72	18,25	63,2	56,0	6,10	8 000	9 500
32207	35	72	24,25	81,2	78,0	8,50	8 000	9 500
33207	35	72	28,00	104,0	106,0	11,80	7 000	9 500
30307	35	80	22,75	88,9	73,5	8,30	7 500	9 000
31307	35	80	22,75	75,4	67,0	7,80	6 300	8 500
32307 J2/Q ¹⁾	35	80	32,75	117,0	106,0	12,20	6 700	9 000
32307 B	35	80	32,75	115,0	114,0	12,90	6 300	8 500
32008 X	40	68	19,00	64,7	71,0	7,65	7 500	9 500
30208	40	80	19,75	75,8	68,0	7,65	7 000	8 500
32208	40	80	24,75	91,6	86,5	9,80	7 000	8 500
33208	40	80	32,00	128,0	132,0	15,00	6 300	8 500
30308	40	90	25,25	106,0	95,0	10,80	6 300	8 000
32308	40	90	35,25	143,0	140,0	16,00	6 000	8 000
33108	40	75	26,00	97,5	104,0	11,40	7 000	9 000
32009 X/Q ¹⁾	45	75	20,00	71,7	80,0	8,80	7 000	8 500
33109	45	80	26,00	104,0	114,0	12,90	6 700	8 000
30209	45	85	20,75	81,6	76,5	8,65	6 300	8 000

¹⁾ TQ-Line execution, supposed to be upgraded to SKF Explorer, please check with your SKF representative



Designation	Dimensions			Basic load ratings		Fatigue load ratings	Speed ratings	
	Inner diameter	Outer diameter	Overall width	dynamic	static		Reference speed	Limiting speed
	d	D	B	C	C ₀	P _u		
–	mm			kN		kN	r/min	
33209	45	85	32,00	132,0	143,0	16,30	6 000	7 500
30309	45	100	27,25	132,0	120,0	14,30	5 600	7 000
32309	45	100	38,25	173,0	170,0	20,40	5 300	7 000
T2ED 045	45	95	36,00	182,0	186,0	20,80	6 000	7 000
32209	45	85	24,75	98,7	98,0	11,00	6 300	8 000
32010 X	50	80	20,00	75,1	88,0	9,65	6 300	8 000
33010/Q¹⁾	50	80	24,00	84,8	102,0	11,40	6 300	8 000
30210	50	90	21,75	93,1	91,5	10,40	6 000	7 500
32210	50	90	24,75	101,0	100,0	11,40	6 000	7 500
33210	50	90	32,00	142,0	160,0	18,30	5 300	7 000
30310	50	110	29,25	154,0	140,0	16,60	5 300	6 300
32310	50	110	42,25	211,0	212,0	24,00	4 800	6 300
T2ED 050	50	100	36,00	189,0	200,0	22,40	5 600	6 700
33110	50	85	26,00	106,0	122,0	13,40	6 000	7 500
32011 X	55	90	23,00	99,4	116,0	12,90	5 600	7 000
33111/Q¹⁾	55	95	30,00	136,0	156,0	17,60	5 600	6 700
30211	55	100	22,75	111,0	106,0	12,00	5 300	6 700
32211	55	100	26,75	130,0	129,0	15,00	5 300	6 700
33211	55	100	35,00	170,0	190,0	21,60	4 800	6 300
30311	55	120	31,50	176,0	163,0	19,30	4 800	5 600
31311	55	120	31,50	149,0	137,0	16,60	4 300	5 600
32311	55	120	45,50	245,0	250,0	28,50	4 300	5 600
33011	55	90	27,00	111,0	137,0	15,30	5 600	7 000
32911/Q¹⁾	55	80	17,00	51,7	69,5	7,20	6 300	7 500
30212	60	110	23,75	120,0	114,0	13,20	5 000	6 000
32212	60	110	29,75	155,0	160,0	18,60	5 000	6 000
33212	60	110	38,00	207,0	236,0	26,50	4 500	6 000
30312 J2/Q¹⁾	60	130	33,50	208,0	196,0	23,60	4 300	5 300
31312	60	130	33,50	177,0	166,0	20,40	3 800	5 300
32312	60	130	48,50	282,0	290,0	34,00	4 000	5 300
T2EE 060	60	115	40,00	239,0	260,0	30,00	4 800	5 600
33012	60	95	27,00	113,0	143,0	16,00	5 300	6 700
33112	60	100	30,00	144,0	170,0	19,60	5 300	6 300
32013 X	65	100	23,00	103,0	127,0	14,00	5 000	6 000
33013	65	100	27,00	119,0	153,0	17,30	5 000	6 300
30213	65	120	24,75	141,0	134,0	16,30	4 500	5 600

¹⁾ TQ-Line execution, supposed to be upgraded to SKF Explorer, please check with your SKF representative

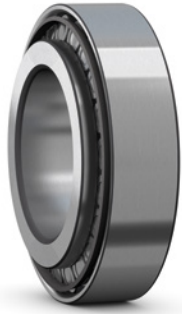

Designation	Dimensions			Basic load ratings		Fatigue load ratings	Speed ratings	
	Inner diameter	Outer diameter	Overall width	dynamic	static		Reference speed	Limiting speed
	d	D	B	C	C ₀	P _u		
–	mm			kN		kN	r/min	
32213	85	180	44,50	186,0	193,0	22,80	4 500	5 600
33213	85	180	63,50	239,0	270,0	30,50	4 000	5 300
30313	90	140	32,00	240,0	228,0	27,50	4 000	4 800
32313	90	140	39,00	323,0	335,0	40,00	3 600	4 800
T2DD 065/Q ¹⁾	90	160	32,50	170,0	193,0	22,40	4 800	6 000
32014 X	90	160	42,50	125,0	153,0	17,30	4 500	5 600
33014	90	190	46,50	159,0	196,0	22,80	4 800	5 600
33114	90	190	46,50	211,0	250,0	28,50	4 300	5 300
30214 J2/Q ¹⁾	90	190	67,50	155,0	156,0	18,00	4 300	5 300
32214 J2/Q ¹⁾	90	160	55,00	195,0	208,0	24,50	4 300	5 300
33214	90	150	45,00	247,0	285,0	32,50	3 800	5 000
30314	95	145	32,00	271,0	260,0	31,00	3 800	4 500
32314	95	145	39,00	363,0	380,0	45,00	3 400	4 500
32015 X	95	170	34,50	130,0	163,0	18,60	4 300	5 300
33015	95	200	71,50	167,0	228,0	26,00	4 300	5 300
33115	95	170	58,00	216,0	265,0	30,00	4 000	5 000
30215	95	170	45,50	171,0	176,0	20,40	4 000	5 000
32215	95	200	49,50	197,0	212,0	24,50	4 000	5 000
33215	100	150	39,00	255,0	300,0	34,00	3 600	4 800
30315	100	180	37,00	301,0	290,0	34,00	3 400	4 300
32315	100	180	49,00	416,0	440,0	51,00	3 200	4 300
32016 X	100	215	51,50	168,0	216,0	24,50	4 000	5 000
33016	100	215	77,50	207,0	285,0	32,00	4 000	5 000
33116	100	145	24,00	221,0	280,0	31,00	4 000	4 800
30216	100	140	25,00	184,0	183,0	21,20	3 800	4 800
32216	100	215	56,50	228,0	245,0	28,50	3 800	4 500
33216	80	140	46,00	308,0	375,0	41,50	3 400	4 500
30316	80	170	42,50	333,0	320,0	36,50	3 200	4 000
32316 J2 ¹⁾	80	170	61,50	404,0	500,0	56,00	3 000	4 000
32017 X	85	130	29,00	171,0	224,0	25,50	3 800	4 800
33017	85	130	36,00	223,0	310,0	34,50	3 800	4 800
33117	85	140	41,00	268,0	340,0	38,00	3 600	4 500
30217	85	150	30,50	216,0	220,0	25,50	3 600	4 300
32217	85	150	38,50	263,0	285,0	33,50	3 600	4 300
33217	85	150	49,00	353,0	430,0	48,00	3 200	4 300
30317 J2	85	180	44,50	372,0	365,0	40,50	3 000	3 800

¹⁾ TQ-Line execution, supposed to be upgraded to SKF Explorer, please check with your SKF representative



Designation	Dimensions			Basic load ratings		Fatigue load ratings	Speed ratings	
	Inner diameter	Outer diameter	Overall width	dynamic	static		Reference speed	Limiting speed
	d	D	B	C	C ₀	P _u		
–	mm			kN		kN		
31317	85	180	44,50	297,0	285,0	32,00	2 800	3 800
32317 J2¹⁾	85	180	63,50	435,0	530,0	60,00	2 800	3 800
32018 X	90	140	32,00	208,0	270,0	31,00	3 600	4 300
33018	90	140	39,00	266,0	355,0	39,00	3 600	4 500
30218	90	160	32,50	240,0	245,0	28,50	3 400	4 000
32218	90	160	42,50	309,0	340,0	38,00	3 400	4 000
30318	90	190	46,50	353,0	400,0	44,00	2 600	3 600
31318	90	190	46,50	283,0	315,0	35,50	2 400	3 400
32318	90	190	67,50	487,0	610,0	65,50	2 600	3 600
33118	90	150	45,00	310,0	390,0	43,00	3 400	4 300
32019 X	95	145	32,00	206,0	270,0	30,50	3 400	4 300
33019	95	145	39,00	272,0	375,0	40,50	3 400	4 300
30219	95	170	34,50	266,0	275,0	31,50	3 200	3 800
32319	95	200	71,50	535,0	670,0	72,00	2 400	3 400
32219	95	170	45,50	348,0	390,0	43,00	3 200	3 800
31319	95	200	49,50	314,0	355,0	39,00	2 400	3 400
33020	100	150	39,00	278,0	390,0	41,50	3 400	4 000
30220	100	180	37,00	304,0	320,0	36,00	3 000	3 600
32220	100	180	49,00	390,0	440,0	48,00	3 000	3 600
30320	100	215	51,50	431,0	490,0	53,00	2 400	3 200
32320	100	215	77,50	617,0	780,0	83,00	2 200	3 200
T4CB 100	100	145	24,00	154,0	190,0	20,80	3 400	4 300
32920	100	140	25,00	147,0	204,0	22,40	3 400	4 300
31320 X	100	215	56,50	399,0	465,0	51,00	2 200	3 000

¹⁾ TQ-Line execution, supposed to be upgraded to SKF Explorer, please check with your SKF representative



Designation	Dimensions			Basic load ratings		Fatigue load ratings	Speed ratings	
	Inner diameter	Outer diameter	Overall width	dynamic	static		Reference speed	Limiting speed
	d	D	B	C	C ₀	P _u		
–	mm			kN		kN	r/min	
L 44643/610/VU990 ²⁾	25,400	50,292	14,224	32,0	30,0	3,00	11 000	13 000
L 44649/610/Q ¹⁾	26,988	50,292	14,224	32,0	30,0	3,00	11 000	13 000
L 45449/410/Q ¹⁾	29,000	50,292	14,224	31,8	32,5	3,35	11 000	13 000
15123/15245	31,750	62,000	18,161	59,5	57,0	6,20	9 000	11 000
LM 48548 A/510	34,925	65,088	18,034	58,0	57,0	6,20	8 500	10 000
L 68149/111/Q ¹⁾	34,987	59,975	15,875	40,6	44,0	4,50	9 000	11 000
L 68149/110/Q ¹⁾	34,987	59,131	15,875	40,6	44,0	4,50	9 000	11 000
LM 29748/710/VU990 ²⁾	38,100	65,088	18,034	53,0	57,0	6,10	8 000	10 000
LM 29749/710/Q	38,100	65,088	18,034	53,0	57,0	6,10	8 000	10 000
HM 801346/310	38,100	82,550	29,370	106,0	118,0	13,40	6 700	8 000
25572/25520/Q ¹⁾	38,100	82,931	23,812	99,1	106,0	11,80	6 700	8 000
16150/16284/Q ¹⁾	38,100	72,238	20,638	60,3	60,0	6,55	8 000	9 500
LM 300849/811/Q ¹⁾	41,000	68,000	17,500	53,6	58,5	6,30	8 000	9 500
LM 501349/310/Q ¹⁾	41,275	73,431	19,558	67,6	68,0	7,65	7 500	9 000
LM 501349/314/Q ¹⁾	41,275	73,431	21,430	67,6	68,0	7,65	7 500	9 000
24780/24720/Q ¹⁾	41,275	76,200	22,225	84,2	86,5	9,65	7 000	9 000
18590/18520/Q ¹⁾	41,275	73,025	16,667	57,7	56,0	6,20	7 500	9 000
535/532 A	44,450	111,125	38,100	183,0	190,0	21,60	5 300	6 300
53178/53377	44,450	95,250	30,958	108,0	96,5	11,40	5 300	7 000
LM 102949/910/Q ¹⁾	45,242	73,431	19,558	66,0	75,0	8,15	7 000	8 500
LM 503349/310/QCL7C ¹⁾	46,000	75,000	18,000	62,1	71,0	7,65	7 000	8 500
18690/18620/Q ¹⁾	46,038	79,375	17,462	61,1	62,0	6,80	7 000	8 500
537/532 X/Q ¹⁾	50,800	107,950	36,512	183,0	190,0	21,60	5 300	6 300
4580/2/4535/2/Q ¹⁾	50,800	104,775	39,688	195,0	224,0	25,00	5 300	6 300
539/532 X	53,975	107,950	36,512	183,0	190,0	21,60	5 300	6 300
462/453 X/VB535 ³⁾	57,150	104,775	30,162	150,0	160,0	18,60	5 300	6 300
39581/39520/Q	57,150	112,712	30,162	175,0	204,0	23,60	4 500	5 600
47487/47420 A/Q ¹⁾	69,850	120,000	32,545	188,0	228,0	26,50	4 300	5 300
42687/42620	76,200	127,000	30,162	171,0	204,0	24,00	4 000	5 000
42690/42620/Q ¹⁾	77,788	127,000	30,163	171,0	204,0	24,00	4 000	5 000
HM 220149/110	100,000	157,000	42,000	303,0	400,0	42,50	3 200	4 000

¹⁾ TQ-Line execution, supposed to be upgraded to SKF Explorer, please check with your SKF representative

²⁾ Standard tapered roller bearing (not SKF Explorer)

³⁾ Different chamfer than standard execution

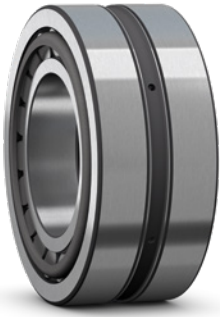

Designation	Dimensions			Basic load ratings		Fatigue load ratings	Speed ratings	
	Inner diameter	Outer diameter	Overall width	dynamic	static		Reference speed	Limiting speed
	d	D	B	C	C ₀	P _u		
–	mm			kN		kN	r/min	
31318/DF	90	190	89,5	486,0	630,0	71,0	1 900	3 400
31318/DFC70	90	190	89,5	486,0	630,0	71,0	1 900	3 400
32219/DF	95	170	88,5	597,0	780,0	86,5	2 600	3 800
31319/DF	95	200	94,5	539,0	710,0	78,0	1 800	3 400
31319/DFC190	95	200	94,5	539,0	710,0	78,0	1 800	3 400
30220/DF	100	180	71,0	521,0	640,0	72,0	2 400	3 600
31320 X/DF	100	215	107,5	685,0	930,0	102,0	1 700	3 000
32220/DF	100	180	95,0	668,0	880,0	96,5	2 400	3 600



CRW1 R



CRW1 NBT



HMS5 RG

HMSA10 RG
HMSA10 RG1

Designation	Dimensions			Material code	Auxiliary lip A = contacting	Speed ratings	
	Inner diameter	Outer diameter	Overall width			m/s	ft/min
–	d	D	B				
	mm						
12x22x7 CRW1 R	12	22	7	NBR	–	18	3 600
14x24x7 HMSA10 RG	14	24	7	NBR	A	14	2 755
15x24x7 HMSA10 RG1	15	24	7	NBR	A	14	2 755
15x35x7 HMSA10 RG	15	35	7	NBR	A	14	2 755
17x35x7 CRW1 R	17	35	7	NBR	–	18	3 600
17x40x7 HMSA10 RG	17	40	7	NBR	A	14	2 755
20x30x7 HMSA10 RG	20	30	7	NBR	A	14	2 755
20x35x7 HMSA10 RG	20	35	7	NBR	A	14	2 755
20x35x7 HMS5 RG	20	35	7	NBR	–	14	2 755
20x40x7 HMSA10 RG	20	40	7	NBR	A	14	2 755
20x47x7 HMSA10 RG	20	47	7	NBR	A	14	2 755
25x35x7 HMSA10 RG	25	35	7	NBR	A	14	2 755
25x35x7 HMS5 RG	25	35	7	NBR	–	14	2 755
25x37x7 HMSA10 RG	25	37	7	NBR	A	14	2 755
25x38x7 HMSA10 RG	25	38	7	NBR	A	14	2 755
25x40x7 HMSA10 RG	25	40	7	NBR	A	14	2 755
25x47x7 HMSA10 RG	25	47	7	NBR	A	14	2 755
25x47x7 HMS5 RG	25	47	7	NBR	–	14	2 755
25x52x7 HMSA10 RG	25	52	7	NBR	A	14	2 755
30x40x7 HMSA10 RG	30	40	7	NBR	A	14	2 755
30x40x7 HMS5 RG	30	40	7	NBR	–	14	2 755
30x45x8 CRW1 R	30	45	8	NBR	–	18	3 600
30x47x7 HMSA10 RG	30	47	7	NBR	A	14	2 755
30x47x7 CRW1 R	30	47	7	NBR	–	18	3 600
30x52x7 HMSA10 RG	30	52	7	NBR	A	14	2 755
30x62x7 HMSA10 RG	30	62	7	NBR	A	14	2 755
35x47x7 HMSA10 RG	35	47	7	NBR	A	14	2 755
35x47x7 HMS5 RG	35	47	7	NBR	–	14	2 755
35x52x7 HMSA10 RG	35	52	7	NBR	A	14	2 755
35x52x7 HMS5 RG	35	52	7	NBR	–	14	2 755
35x55x10 HMSA10 RG	35	55	10	NBR	A	14	2 755
35x58x10 HMSA10 RG	35	58	10	NBR	A	14	2 755
35x62x7 HMS5 RG	35	62	7	NBR	–	14	2 755
35x72x8 CRW1 R	35	72	8	NBR	–	18	3 600
35x72x10 HMSA10 RG	35	72	10	NBR	A	14	2 755
38x52x7 HMSA10 RG	38	52	7	NBR	A	14	2 755



CRW1 R



HMS5 RG



HMSA10 RG



HMSA10 V

Designation	Dimensions			Material code	Auxiliary lip A = contacting	Speed ratings	
	Inner diameter	Outer diameter	Overall width				
	d	D	B			m/s	ft/min
–	mm						
40x52x7 HMSA10 RG	40	52	7	NBR	A	14	2 755
40x55x7 HMS5 RG	40	55	7	NBR	–	14	2 755
40x62x7 HMSA10 RG	40	62	7	NBR	A	14	2 755
40x80x10 HMSA10 RG	40	80	10	NBR	A	14	2 755
45x62x7 HMSA10 V	45	62	7	FKM	A	14	2 755
45x62x10 HMSA10 RG	45	62	10	NBR	A	14	2 755
45x65x8 HMSA10 RG	45	65	8	NBR	A	14	2 755
45x65x8 HMS5 RG	45	65	8	NBR	–	14	2 755
45x72x8 HMSA10 RG	45	72	8	NBR	A	14	2 755
45x72x8 HMS5 RG	45	72	8	NBR	–	14	2 755
45x75x8 HMSA10 RG	45	75	8	NBR	A	14	2 755
46x68x8 CRW1 R	46	68	8	NBR	–	18	3 600
50x68x8 CRW1 R	50	68	8	NBR	–	18	3 600
50x72x8 HMSA10 RG	50	72	8	NBR	A	14	2 755
50x80x8 HMSA10 RG	50	80	8	NBR	A	14	2 755
50x80x10 HMSA10 RG	50	80	10	NBR	A	14	2 755
55x72x8 HMSA10 RG	55	72	8	NBR	A	14	2 755
55x80x8 HMSA10 RG	55	80	8	NBR	A	14	2 755
60x75x8 HMS5 RG	60	75	8	NBR	–	14	2 755
60x80x10 HMS5 RG	60	80	10	NBR	–	14	755
63x90x10 HMSA10 RG	63	90	10	NBR	A	14	2 755
65x85x10 HMSA10 RG	65	85	10	NBR	A	14	2 755
65x100x10 HMSA10 RG	65	100	10	NBR	A	14	2 755
70x85x8 HMSA10 RG	70	85	8	NBR	A	14	2 755
70x90x10 HMSA10 RG	70	90	10	NBR	A	14	2 755
75x95x10 HMSA10 RG	75	95	10	NBR	A	14	2 755
75x100x10 HMS5 RG	75	100	10	NBR	–	14	2 755



CRW1 R



CRW1 V



CRWA1 R



CRWA1 V



CRWA5 R

Designation	Design	Dimensions			Material code	Auxiliary lip A = contacting	Speed ratings	
		Inner diameter d	Outer diameter D	Overall width B			m/s	ft/min
		mm						
4985	CRWA1 R	12,70	25,37	6,35	NBR	A	18	3 600
6904	CRWA1 R	15,88	28,55	6,35	NBR	A	18	3 600
6229	CRWA5 R	15,88	28,55	9,53	NBR	A	10	2 000
6373	CRWA1 R	15,88	34,93	6,35	NBR	A	18	3 600
7443	CRWA1 R	19,05	31,75	6,50	NBR	A	18	3 600
7512	CRW1 R	19,05	34,93	6,35	NBR	–	18	3 600
7513	CRWA1 R	19,05	34,93	6,35	NBR	A	18	3 600
8624	CRW1 R	22,23	31,75	4,78	NBR	–	18	3 600
8660	CRWA5 R	22,23	34,93	6,35	NBR	A	10	2 000
8648	CRW1 R	22,23	34,93	6,50	NBR	–	18	3 600
8700	CRW1 R	22,23	38,07	6,35	NBR	–	18	3 600
9837	CRW1 R	25,40	36,50	6,35	NBR	–	18	3 600
9833	CRW1 V	25,40	36,50	6,35	FKM	–	18	3 600
9843	CRWA5 R	25,40	38,07	6,35	NBR	A	10	2 000
9876	CRW1 R	25,40	38,07	6,35	NBR	–	18	3 600
9878	CRWA1 R	25,40	38,07	6,35	NBR	A	18	3 600
9934	CRW1 R	25,40	41,25	6,35	NBR	–	18	3 600
9935	CRWA1 R	25,40	41,25	6,35	NBR	A	18	3 600
9998	CRWA1 R	25,40	44,50	6,35	NBR	A	18	3 600
10114	CRWA1 R	25,40	50,37	7,95	NBR	A	18	3 600
10124	CRWA1 R	25,40	50,80	6,35	NBR	A	18	3 600
10681	CRW1 R	27,00	46,43	6,35	NBR	–	18	3 600
10740	CRW1 R	27,00	50,80	6,35	NBR	–	18	3 600
11067	CRW1 R	28,58	39,65	6,50	NBR	–	18	3 600
11123	CRW1 R	28,58	41,25	6,35	NBR	–	18	3 600
11124	CRWA1 R	28,58	41,25	6,50	NBR	A	18	3 600
11223	CRWA1 R	28,58	47,60	6,35	NBR	A	18	3 600
12350	CRWA1 R	31,75	42,85	7,95	NBR	A	18	3 600
12364	CRWA1 R	31,75	44,50	6,35	NBR	A	18	3 600
12363	CRW1 R	31,75	44,50	6,35	NBR	–	18	3 600
12383	CRWA1 V	31,75	47,60	6,35	FKM	A	18	3 600
12427	CRW1 R	31,75	50,37	6,35	NBR	–	18	3 600
12428	CRWA1 R	31,75	50,37	6,35	NBR	A	18	3 600
12456	CRW1 R	31,75	50,80	6,35	NBR	–	18	3 600
12458	CRWA1 R	31,75	50,80	6,35	NBR	A	18	3 600
12577	CRW1 R	31,75	57,15	6,35	NBR	–	18	3 600

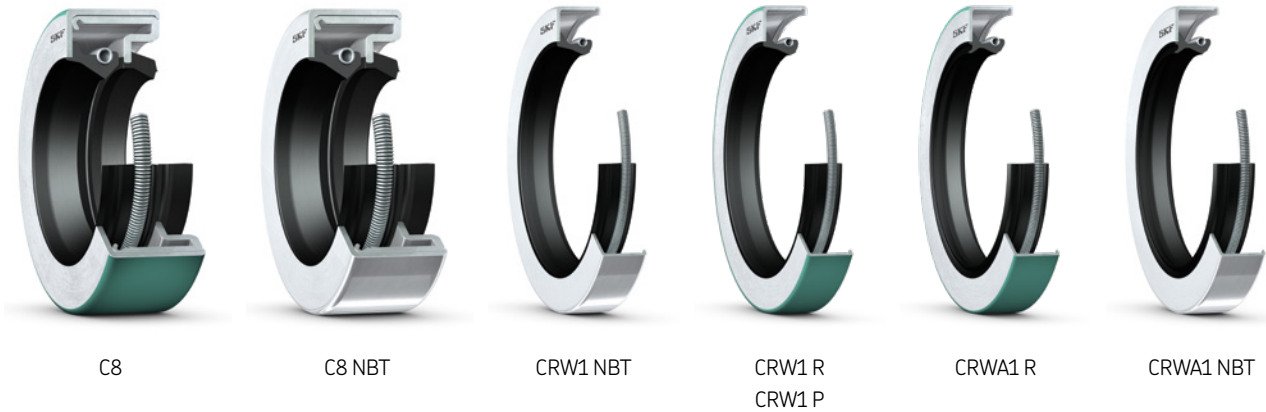

Designation	Design	Dimensions			Material code	Auxiliary lip A = contacting	Speed ratings	
		Inner diameter d	Outer diameter D	Overall width B			m/s	ft/min
–		mm					m/s	ft/min
12614	CRWA1 R	31,75	60,30	7,95	NBR	A	18	3 600
13534	CRW1 R	34,93	47,60	6,50	NBR	–	18	3 600
13535	CRWA1 R	34,93	47,60	7,95	NBR	A	18	3 600
13569	CRWA1 R	34,93	50,80	7,95	NBR	A	18	3 600
13651	CRWA1 R	34,93	53,98	7,95	NBR	A	18	3 600
13649	CRW1 R	34,93	53,98	7,95	NBR	–	18	3 600
13865	CRW1 R	34,93	63,55	7,95	NBR	–	18	3 600
14807	CRW1 NBT	38,10	47,60	6,35	NBR	–	18	3 600
14832	CRW1 R	38,10	50,37	7,95	NBR	–	18	3 600
14855	CRW1 R	38,10	50,80	7,95	NBR	–	18	3 600
14939	CRWA1 R	38,10	57,15	7,95	NBR	A	18	3 600
14938	CRW1 R	38,10	57,15	7,95	NBR	–	18	3 600
15005	CRWA1 R	38,10	60,30	7,95	NBR	A	18	3 600
15093	CRWA1 R	38,10	62,00	7,95	NBR	A	18	3 600
15142	CRWA1 R	38,10	63,55	7,95	NBR	A	18	3 600
15176	CRW1 R	38,10	65,05	7,95	NBR	–	18	3 600
15517	CRW1 NBT	39,70	53,98	7,95	NBR	–	18	3 600
15707	CRW1 R	39,70	68,22	7,95	NBR	–	18	3 600
16062	CRWA1 R	41,28	57,10	7,95	NBR	A	18	3 600
16085	CRWA1 R	41,28	60,30	7,95	NBR	A	18	3 600
16128	CRWA1 R	41,28	61,90	7,95	NBR	A	18	3 600
16314	CRW1 R	41,28	66,62	7,95	NBR	–	18	3 600
16364	CRW1 R	41,28	69,85	6,35	NBR	–	18	3 600
16900	CRW1 NBT	42,88	69,85	7,95	NBR	–	18	3 600
17231	CRW1 R	44,45	57,15	7,95	NBR	–	18	3 600
17271	CRWA1 R	44,45	60,30	7,95	NBR	A	18	3 600
17285	CRWA1 R	44,45	61,90	8,00	NBR	A	18	3 600
17387	CRWA1 R	44,45	63,55	7,95	NBR	A	18	3 600
17386	CRW1 R	44,45	63,55	7,95	NBR	–	18	3 600
17404	CRW1 R	44,45	65,05	7,95	NBR	–	18	3 600
17443	CRWA1 R	44,45	66,62	7,95	NBR	A	18	3 600
17607	CRWA1 R	44,45	69,00	11,13	NBR	A	18	3 600
17523	CRWA1 R	44,45	69,85	7,95	NBR	A	18	3 600
17557	CRW1 R	44,45	69,85	7,95	NBR	–	18	3 600
17653	CRW1 R	44,45	73,03	7,95	NBR	–	18	3 600
18565	CRW1 R	47,63	63,55	7,95	NBR	–	18	3 600



Designation	Design	Dimensions			Material code	Auxiliary lip A = contacting	Speed ratings	
		Inner diameter d	Outer diameter D	Overall width B			m/s	ft/min
		mm						
18562	CRW1 P	47,63	65,07	7,95	ACM	–	18	3 600
18581	CRWA1 R	47,63	66,62	7,95	NBR	A	18	3 600
18671	CRW1 R	47,63	70,05	7,95	ACM	–	18	3 600
19227	CRWA1 V	49,23	66,62	7,95	FKM	A	18	3 600
19229	CRWA1 R	49,23	66,62	7,95	NBR	A	18	3 600
19359	CRW1 R	49,23	76,20	7,95	NBR	–	18	3 600
19360	CRWA1 NBT	49,23	76,20	7,95	NBR	A	18	3 600
19380	CRW1 R	49,23	77,75	7,95	NBR	–	18	3 600
19745	CRW1 P	50,80	63,55	7,95	ACM	–	18	3 600
19762	CRWA1 R	50,80	66,62	7,95	NBR	A	18	3 600
19786	CRWA1 R	50,80	68,99	9,53	NBR	A	18	3 600
19832	CRWA1 R	50,80	69,85	7,95	NBR	A	18	3 600
19876	C8 NBT	50,80	73,00	17,86	NBR	–	–	–
19969	CRWH1 R	50,80	76,12	9,53	NBR	–	18	3 600
19979	CRWH1 V	50,80	76,12	9,53	FKM	–	18	3 600
21352	CRWA1 R	53,98	85,62	9,53	NBR	A	18	3 600
22354	CRWA1 R	57,15	76,20	9,53	NBR	A	18	3 600
22400	CRWA1 R	57,15	79,38	9,53	NBR	A	18	3 600
22493	CRWHA1 R	57,15	85,09	11,13	NBR	A	18	3 600
22532	CRWHA1 R	57,15	85,62	11,13	NBR	A	18	3 600
22558	CRWH1 R	57,15	85,62	11,13	NBR	–	18	3 600
23061	CRW1 R	58,75	79,38	9,53	NBR	–	18	3 600
23184	CRW1 NBT	58,75	88,90	7,95	NBR	–	18	3 600
24898	CRWA1 R	63,50	82,58	9,53	NBR	A	18	3 600
24899	CRWA1 V	63,50	82,58	9,53	FKM	A	18	3 600
24988	CRWHA1 R	63,50	88,90	11,13	NBR	A	18	3 600
25091	CRWH1 NBT	63,50	95,28	11,13	NBR	–	18	3 600
25102	CRWHA1 P	63,50	98,45	11,91	ACM	A	18	3 600
27269	CRWA1 R	69,85	88,90	9,53	NBR	A	18	3 600
27362	CRWA1 R	69,85	95,28	11,13	NBR	A	18	3 600
27368	CRWH1 R	69,85	95,28	11,13	NBR	–	18	3 600
27370	CRWHA1 R	69,85	95,28	11,13	NBR	A	18	3 600
27565	CRWHA1 NBT	69,85	101,68	11,13	ACM	A	18	3 600
27625	CRWHA1 R	69,85	110,00	12,70	NBR	A	18	3 600
28790	C8	73,03	101,68	19,05	NBR	–	–	–
29224	CRWA1 R	74,63	95,28	9,53	NBR	A	18	3 600



CRW1 R



CRWA1 R



CRWH1 R



CRWHA1 R

Designation	Design	Dimensions			Material code	Auxiliary lip A = contacting	Speed ratings	
		Inner diameter d	Outer diameter D	Overall width B			m/s	ft/min
–		mm						
29906	CRW1 R	76,20	101,68	9,53	NBR	–	18	3 600
29907	CRWA1 R	76,20	101,68	9,53	NBR	A	18	3 600
30087	CRWH1 R	76,20	114,30	11,13	NBR	–	18	3 600
30095	CRWHA1 R	76,20	114,30	11,13	NBR	A	18	3 600
33701	CRWA1 R	85,73	111,15	9,53	NBR	A	18	3 600
33772	CRWH1 R	85,73	117,50	11,13	NBR	–	18	3 600
43771	CRWH1 R	111,13	152,43	12,70	NBR	–	18	3 600
52488	CRWH1 R	133,35	165,10	12,70	NBR	–	18	3 600

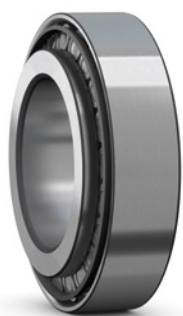

Tapered roller bearing



SKF Mudblock

Designation	Dimensions				Basic load ratings		Fatigue load ratings	Speed ratings	
	Inner diameter	Outer diameter	Overall width	Sleeve width	dynamic	static		Reference speed	Limiting speed
	d	D	B		C	C ₀	P _u		
–	mm				kN		kN	r/min	

Driven front wheel end – Tapered roller bearing

PER.JL819349/10	95,000	135,000	20,000	–	82,9	147	17,9	2 739	3 721
PER.37431A/37625	109,538	158,750	23,020	–	106,0	174	21,2	2 530	3 365

Wheel end – SKF Mudblock¹⁾

55x80 MUD11 R	55,000	80,000	13,5	14,5	–	–	–	150	300
56x80 MUD11 R	56,000	80,000	13,5	14,5	–	–	–	150	300
60x90 MUD11 R	60,000	90,000	14,5	15,5	–	–	–	150	300
65x90 MUD11 R	65,000	90,000	14,5	15,5	–	–	–	150	300
65x95 MUD11 R	65,000	95,000	14,5	15,5	–	–	–	150	300
70x95 MUD11 R	70,000	95,000	14,5	15,5	–	–	–	150	300
70x100 MUD11 R	70,000	100,000	14,5	15,5	–	–	–	150	300
75x105 MUD11 R	75,000	105,000	14,5	15,5	–	–	–	150	300
80x110 MUD11 R	80,000	110,000	14,5	15,5	–	–	–	150	300
85x115 MUD11 R	85,000	115,000	14,5	15,5	–	–	–	150	300
90x120 MUD11 R	90,000	120,000	14,5	15,5	–	–	–	150	300
100x130 MUD11 R	100,000	130,000	14,5	15,5	–	–	–	150	300
110x140 MUD11 R	110,000	140,000	15,0	16,0	–	–	–	150	300
130x160 MUD11 R	130,000	160,000	15,0	16,0	–	–	–	150	300
140x170 MUD11 R	140,000	170,000	15,0	16,0	–	–	–	150	300
145x175 MUD11 R	145,000	175,000	15,0	16,0	–	–	–	150	300
150x180 MUD11 R	150,000	180,000	15,0	16,0	–	–	–	150	300
165x190 MUD11 R	165,000	190,000	15,0	16,0	–	–	–	150	300
170x200 MUD11 R	170,000	200,000	15,0	16,0	–	–	–	150	300

¹⁾ Tolerance d=H8, Tolerance D=h8

Tillage

Tillage is the first step of the agriculture process and typically is carried out twice per year, in spring and autumn. The purpose is to prepare the soil for new seed. This means turning nutritious soil to the surface and integrating crop residues to a lower layer of the soil to facilitate decay. Another important purpose for tillage is to break up the soil so that it will achieve the right balance of moisture and air to avoid soil erosion. This is done by using tillage discs to cut through the soil and seedbed finishers to then level and firm.

The potential gains for a farmer using the right components for tillage equipment can be significant: increased productivity by up to 150%, reduced cost of ownership by up to 30% and easier installation and repair.

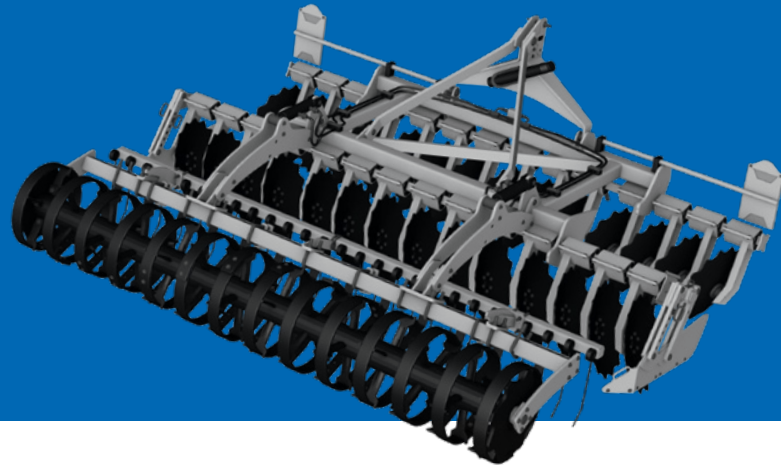

Application challenges

- Very harsh environment: mud, water, dust and crop residues
- Tilting forces, shock loads and stone impacts
- Higher machine speeds (for higher productivity)
- Avoiding tillage machine downtime during the season

If the tillage bearings are not customized and prepared for these kinds of conditions, it can easily lead to damage and early life failure. This is especially true if the seal fails or if a re-lubricated bearing is not regularly re-greased. Such events lower the productivity, increase maintenance costs and reduce overall profitability. It can also impact the precision and thus, the quality of the farmer's work.

Primary tillage



Disc plough

Typical conditions for disc plough applications

The initial major soil working operation designed to plough the soil deeply to reduce soil strength, cover plant materials and rearrange aggregates is called primary tillage.

The main implement used for primary tillage is a plough. Ploughing essentially consists of opening the upper crust of the soil, breaking the clods and making the soil suitable for sowing seeds.

One plough machine is the disc plough. Disc plough cuts, turns and in some cases breaks furrow slices by means of separately mounted large steel concave discs. A disc plough is designed to reduce friction by making a rolling plough bottom instead of sliding plough bottom as in the case of mouldboard plough. A disc plough works well where mouldboard ploughs do not work satisfactorily.

Application challenges

- Very harsh environment: mud, water, dust and crop residues
- High Tilting forces, shock loads and stone impacts
- Avoiding disc plough machine downtime during the season

SKF Agri Hub Disc Plough

SKF designed and developed a ready to mount and dismount SKF Agri Hub Disc Plough.

Benefits

- OEMs
 - Simplified supply chain
 - Assembly cost
- End-users
 - Reduced downtime
 - Increased service life during season
 - Relubrication-free

Secondary tillage



Independent tillage disc

Typical conditions for independent disc applications

- Disc speed: 90–350 r/min
- Tractor speed: up to 20 km/h

Solutions for independent disc applications

Among the many products especially developed to handle harsh conditions for independent disc applications, SKF offers both bearings and complete hub units. One of the most robust solutions is the SKF Agri Hub, consisting of angular contact ball bearings which are greased and sealed for-life, a cassette seal, stub shaft for the arm interface and flange for disc mounting. The integrated nature of the hub facilitates mounting and prolongs its service life to maximize the yield and the availability of agricultural machines.

Benefits of SKF Agri Hub for tillage

- OEMs
 - Cost-effective solution
 - Higher product quality and reliability
 - Supports sustainability efforts
 - Reduces assembly times
- End-users
 - Increased farm productivity and profitability
 - Relubrication-free
 - Environmentally friendly
 - Easy to install/replace



Gang disc

Typical conditions for gang disc applications

- Tractor speed up to 12 km/h
- Utilizes two to three support bearings on a common shaft with several discs spaced with spools
- Constant and unpredictable movement of the gang shaft can generate severe stress on the internal components of the support bearings
- A great working depth places the bearings directly into the flow of soil and crop residue

Solutions for gang disc applications

One of the most commonly used gang disc bearing arrangements is the trunnion housing.

Benefits and functional features of PEER Tillage Trunnion Unit (TTU)

- Bolt-on performance
 - Directly interchangeable industry standard units
 - Static misalignment capability can accommodate imprecise mounting surfaces
- Increased productivity and bearing life in field
 - Dynamic misalignment capability can reduce internal bearing damage
 - Shock load protection due to high grade ductile iron housing
 - Patented sealing system can avoid the need for relubrication

Seedbed finisher for independent tillage disc and gang disc

Typical conditions for seedbed finisher applications

- Two bearing units, one at each end of the finisher.
- Operates closely/directly in soil.
- Subject to high misalignment forces
 - statically due to imprecise mounting surfaces, and
 - dynamically due to the wide bearing span and attachment deflections.

Solutions for seedbed finisher applications

The bearing arrangements best suited to seedbed finisher applications are SKF flanged insert bearing units. They come in a variety of designs with both square flange and oval flange. Common to all insert bearing solutions for agriculture applications though is that they are relubrication-free with a five-lip seal to withstand the tough operating conditions.

Benefits of insert bearing units

- OEMs
 - Differentiated designs
 - Reduced warranty, engineering, testing and assembly costs
- End-users
 - Extend service life up to 30% to 50% when fitted with five-lip seal
 - Increase farm productivity
 - Reduce maintenance and ownership costs
 - Reduce environmental impact

¹⁾ Based on SKF testing against conventional bearings. Savings and results will vary in specific applications.



Agri Hub P100¹⁾
Type 1

Designation	Type	Number of holes	Size of holes	Pitch diameter	Performance	Disc diameter
–		–	–	mm	–	mm
Disc – Agri Hub BX-AGPU40236X4N01-MC	1	4	15	236,22	P100	up to 710

¹⁾ Other design variants available upon request



Agri Hub T50
Type 2



Agri Hub T50/T200
Type 3

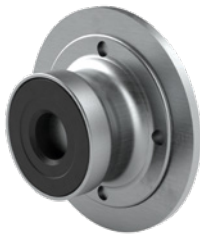

Agri Hub T50/T100
Type 4



Agri Hub T100/T200
Type 5

Designation	Type	Pitch diameter	Holes	Shaft Thread	Arm Hole round/flat	Housing width	Total width	Performance	Disc diameter
–		mm	–	mm				–	mm
Independent tillage disc – Agri Hub									
AGHU2898X4E-DSCS	2	98,0	4	M22x1,5	28/25,5	60,0	102,0	T50	up to 610
AGHU2898X5E-DSCS	2	98,0	5	M22x1,5	28/25,5	60,0	102,0	T50	up to 610
AGHU2898X6E-DSCS	2	98,0	6	M22x1,5	28/25,5	60,0	102,0	T50	up to 610
PER.HUB30-001	2	98,0	4	M22x1,5	28/25,5	45,0	88,0	T50	up to 550
PER.KITHUB30-001 ¹⁾	2	98,0	4	M22x1,5	28/25,5	45,0	88,0	T50	up to 550
PER.HUB30-022	3	98,0	4	M22x1,5	28/25,5	60,0	112,0	T50	up to 550
PER.HUB30-010	3	98,0	4	M20x1,0	28/23	80,0	120,0	T50	up to 550
PER.KITHUB30-003 ¹⁾	3	98,0	4	M22x1,5	28/25,5	60,0	104,0	T50	up to 550
PER.KITHUB30-004 ¹⁾	3	98,0	6	M22x1,5	28/25,5	60,0	102,0	T50	up to 550
PER.HUB30-011	3	98,0	4	M22x1,5	28/25,5	62,0	98,0	T50	up to 550
BAA 0003	4	98,0	4	hole 30	30	58,5	59,0	T100	up to 610
BAA 0003 A	4	98,0	4	hole 30	30	59,0	59,0	T100	up to 610
BAA-0004	5	98,0	4	M22x1,5	28/25,5	60,0	102,0	T100	up to 610
BAA 0005	5	98,0	4	M24x2,0	28/25,5	60,0	105,0	T100	up to 610
BAA-0006	5	98,0	6	M22x1,5	28/25,5	60,0	102,0	T100	up to 610
BAA-0012	5	98,0	5	M22x1,5	28/25,5	60,0	102,0	T100	up to 610
BAA-0013	5	98,0	6	M24x2,0	30/27,5	60,0	106,0	T100	up to 610
BAA-0023	5	98,0	4	M22x1,5	28/25,5	60,0	102,0	T100	up to 610
BAA-0044	5	98,0	4	M22x1,5	28/25,5	60,0	102,0	T200	up to 610
BAA-0047	5	98,0	5	M22x1,5	28/25,5	60,0	102,0	T200	up to 610
BAA-0048	5	98,0	6	M22x1,5	28/25,5	60,0	102,0	T200	up to 610

¹⁾ Item includes additional mounting parts (nuts, washers and screws)



Agri Hub T50/T200
Type 1



Agri Hub T50/T200
Type 2

Designation	Type	Pitch diameter	Holes	Shaft Thread	Arm Hole round/flat	Housing width	Total width	Performance	Disc diameter
–		mm	–	mm				–	mm
Independent tillage disc – Agri Hub									
PER.KITHUB35-001 ¹⁾	1	112,0	5	M24x2,0	30/28	52,5	98,5	T50	up to 610
PER.HUB35-005	1	112,0	5	M24x2	30/28	53,5	98,5	T50	600-650
PER.KITHUB35-002 ¹⁾	1	150,0	6	M24x2,0	30/28	61,0	116,0	T50	600-650
PER.HUB35-006	1	150,0	6	M24x2	30/28	61,0	119,0	T50	600-650
PER.HUB40-008	1	113,0	5	M27x2	36/33,5	55,0	111,0	T50	up to 700
PER.HUB40-009	1	130,0	6	M27x2	36/33,5	55,0	111,0	T50	up to 700
PER.HUB40-001	1	140,0	5	M27x2	36/33,5	55,0	111,0	T50	up to 700
PER.KITHUB40-001 ¹⁾	1	140,0	5	M27x2,0	36/33,5	55,0	111,0	T50	up to 700
PER.HUB40-004	1	140,0	5	M27x2	36/33,5	55,0	111,0	T50	up to 700
PER.HUB40-007	1	140,0	5	M27x2	36/33,5	55,0	111,0	T50	up to 700
PER.HUB40-002	2	122,0	6	M20x1,5	34/31	55,0	70,0	T50	up to 700
BAA-0037	2	133,3	4	M20x1,5	34,9/31	67,0	82,0	T200	up to 750
BAA-0045	1	139,0	5	M24x2	34,9/31	67,0	127,0	T200	up to 750

¹⁾ Item includes additional mounting parts (nuts, washers and screws)



Double row angular contact ball bearing
Type 3



Hub bearing unit (HBU1)
Type 4

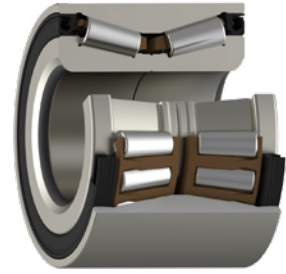

Hub bearing unit (HBU1T)
Type 5

Designation	Type	Bore diameter	Outer diameter	Max. width	Seal type
–		mm			–
Independent tillage disc – Double row angular contact ball bearing (DRACBB)					
3206 CETN9	3	30	62	23,8	–
3206 CE-2RSH1TN9	3	30	62	23,8	1-lip RS1
3306 CETN9	3	30	72	30,2	–
3306 CE-2RSH1TN9	3	30	72	30,2	1-lip RS1
3207 CETN9	3	35	72	27,0	–
3207 CE-2RSH1TN9	3	35	72	27,0	1-lip RS1
3307 CETN9	3	35	80	34,9	–
3307 CE-2RSH1TN9	3	35	80	34,9	1-lip RS1
Independent tillage disc – Hub bearing unit					
BAHB 636187 C	4	40	80	36,0	CS
BTH-1024 AE	5	40	73	55,0	CS



Cylindrical bearing with wide inner ring
Type 1



Cylindrical bearing with flush inner ring
Type 2



Cylindrical bearing with wide inner ring
Type 3



Spherical bearing with wide inner ring
Type 4



Spherical bearing with flush inner ring
Type 5



Spherical bearing with wide inner ring
Type 6

Designation	Type	Bore/shaft diameter	Outer diameter	Max. width	Seal type
–		mm			–

Gang disc – Relubricatable bearings

PER.GW208SPPB6	6	26,162	80,000	36,512	3-lip LS
PER.GW210SPPB4	10	29,413	90,000	30,162	3-lip LS
PER.GW208SPP5	3	29,972	80,000	36,512	3-lip LS
PER.GW208SPPB5	6	29,972	80,000	36,512	3-lip LS
PER.GW208SPPB8	6	29,972	80,000	36,512	3-lip LS
PER.GW208SPP17	3	29,972	85,738	36,512	3-lip LS
PER.GW209SPPB5	6	32,512	85,000	36,512	3-lip LS
PER.GW209SPP8	3	32,512	85,000	36,512	3-lip LS
PER.GW211SPP3	7	38,887	100,000	33,335	3-lip LS
PER.GW211SPPB3	10	38,887	100,000	33,338	3-lip LS
PER.GW211SPP17	3	38,887	100,000	44,450	3-lip LS
PER.GW212SPP50	3	45,466	110,000	50,800	3-lip LS
PER.GW214SPPB4	10	52,200	125,000	39,688	3-lip LS
PER.GW216SPP2	3	58,738	140,000	63,500	3-lip LS
PER.GW209RPPB4	5	38,989	85,000	30,163	3-lip LS
PER.GW209RPPB2	5	45,000	85,000	30,163	3-lip LS
PER.GW209RPPB11	4	45,161	85,000	36,512	3-lip LS
PER.GW211RPPB13	4	45,339	100,000	33,325	3-lip LS
PER.GW211RPP25	1	45,339	100,000	44,450	3-lip LS
PER.GW210RPP54	1	49,225	90,000	49,212	3-lip LS ¹⁾
PER.GW214RPPB3	5	49,225	125,000	39,688	3-lip LS
PER.GW211RPP53	1	50,000	100,000	44,450	3-lip LS
PER.GW211RPPB14	4	51,181	100,000	33,338	3-lip LS
PER.GW211RPP32	1	51,562	100,000	60,325	3-lip LS
PER.GW211RPPB2	5	55,575	100,000	33,338	3-lip LS
PER.GW211RPP2	2	55,575	100,000	33,338	3-lip LS
PER.GW211RPPB8	4	55,575	100,000	33,338	3-lip LS
PER.GW211RPPB9	4	55,753	100,000	39,688	3-lip LS
PER.GW214RPPB6	4	68,278	125,000	68,263	3-lip LS
PER.GW214RPP3	1	68,278	125,000	68,262	3-lip LS
PER.GW214RPP2	2	70,000	125,000	39,688	3-lip LS
PER.GW214RPPB2	5	70,000	125,000	39,688	3-lip LS
PER.GW315RPPB11	5	70,000	160,000	68,260	3-lip LS

¹⁾ With seal added outside



Cylindrical bearing with flush inner ring
Type 7



Sealed cylindrical bearing with wide inner ring
Type 8



Cylindrical bearing with wide inner ring
Type 9



Spherical bearing with flush inner ring
Type 10



Special spherical bearing with wide inner ring
Type 11

Designation	Type	Bore/shaft diameter	Outer diameter	Max. width	Seal type
–		mm			–
Gang disc – Non-relubricatable bearings					
PER.W208SPP6	3	26,162	80,000	36,512	3-lip LS
PER.W208SPPB6	6	26,162	80,000	36,512	3-lip LS
PER.W210SPPB4	10	29,413	90,000	30,162	3-lip LS
PER.W208SPPB8	6	29,972	80,000	36,512	3-lip LS
PER.W208SPP5	3	29,972	80,000	36,512	3-lip LS
PER.W208SPP8	3	29,972	80,000	36,512	3-lip LS
PER.W208SPPB5	6	29,972	80,000	36,512	3-lip LS
PER.W210SPP4-A	7	29,413	90,000	30,162	3-lip LS
PER.W209SPPB5	6	32,512	85,000	36,512	3-lip LS
PER.W211SPP3	7	38,887	100,000	33,338	3-lip LS
PER.W211SPPB3	10	38,887	100,000	33,338	3-lip LS
PER.W211SPP5	3	38,887	101,600	44,450	3-lip LS
PER.W211SPPB6	11	38,887	103,556	44,450	3-lip LS
PER.W208RPPB7	4	30,175	80,000	30,162	3-lip LS
PER.W208RPPB23	4	38,113	80,000	42,862	3-lip LS
PER.W208RPP10	1	38,113	80,000	42,862	3-lip LS
PER.W209RPPB4	5	38,989	85,000	30,162	3-lip LS
PER.W209RPPB2	5	45,000	85,000	30,175	3-lip LS
PER.W210RPPB5	5	45,339	90,000	30,162	3-lip LS
PER.W210RPP2	2	49,225	90,000	30,162	3-lip LS
PER.W210RPPB2	5	49,225	90,000	30,162	3-lip LS
PER.W210R	9	49,225	90,000	49,212	–
PER.W210RPP10	1	49,225	90,000	49,212	3-lip LS
PER.W211RPP5 ²⁾	8	52,413	100,000	55,562	3-lip LS
PER.W211RPP2	2	55,575	100,000	33,338	3-lip LS
PER.W211RPPB4 ¹⁾	11	55,575	100,000	55,562	3-lip LS
PER.W211RPP2-A	2	55,575	100,000	33,338	3-lip LS
PER.W211RPPB2	5	55,575	100,000	33,338	3-lip LS

¹⁾ Round bore
²⁾ With removeable seals



Tillage Trunnion Unit with hanger (TTU)
Type 1



Tillage Trunnion Unit with hanger (TTU)
Type 2



Tillage Trunnion Unit (TTU)
Type 3



Tillage Trunnion Unit (TTU)
Type 4



Tillage Pillowblock Unit (TPU)
Type 5



Tillage Unit
Type 6

Designation	Type	Bore/shaft diameter	Base to center line	Pin/ trunnion diameter	Distance of bolt centers	Seal type
–		mm				–
Gang disc – Tillage units						
PER.GW211SPP17-TTU	4	38,887	–	34,400	–	3-lip LS
PER.W211SS59-TTU	4	38,887	–	34,925	–	6-lip
PER.GW211RPP25-TTU	3	45,339	–	34,400	–	3-lip LS
PER.W211RNN56-TTU-A	3	45,339	–	34,925	–	7-lip
PER.W211RNN56-TTU	3	45,339	–	34,925	–	7-lip
PER.W214SNN54-TTU	4	50,000	–	38,100	–	7-lip
PER.W211RSS58-TTU	3	50,018	–	34,925	–	6-lip
PER.W214SNN60-TTUHG	2	41,350	105	–	155,575	7-lip
PER.W214RSS51-TTUHG	1	68,278	90	–	165,900	6-lip
PER.W211RSSB57-TPU	5	45,339	81	–	139,700	6-lip
PER.GW209RPPB22-BR	6	38,989	–	–	–	3-lip LS
PER.GW209RPPB23-BR	6	45,085	–	–	–	3-lip LS
PER.GW211RPPB21-BR	6	45,339	–	–	–	3-lip LS



Flanged unit with set screw
Type 7



Flanged unit without set screw
Type 8



Flanged unit assembly
Type 9



Bolt flange unit with grip it locking collar
Type 10



Bolt round flange unit with set screw
Type 11



Flanged disc with round bore
Type 12

Designation	Type	Bore/shaft diameter	Fixing dimension square	Width to flange backside	Seal type
–		mm			–
Seedbed finisher – Flanged unit assembly					
PER.UCNF208A-A	7	40,000	101,60	51,40	5-lip
PER.UCNF208A-B	7	40,000	101,60	56,70	5-lip
PER.UCF208A-C	7	40,000	101,60	56,70	5-lip
PER.UCNF209A-A	7	45,000	105,00	52,40	5-lip
PER.UCNFS210A-A	7	50,000	111,10	61,60	5 and 6-lip
PER.UCNF210A-B	7	50,000	111,10	60,00	5-lip
PER.UCNF210A-A	7	50,000	111,10	54,80	5-lip
PER.UCNFS210A-B	7	50,000	111,10	61,60	5 and 6-lip
PER.UCFX11-32A-A	7	50,800	142,90	88,60	1-lip G
PER.UCFX12-38A-A	7	60,325	149,00	94,00	1-lip G
PER.UCFX13AT-B	7	65,000	152,40	75,40	3-lip LS
PER.W308RRPB52-F-A	8	40,000	102,00	53,00	6-lip
PER.W210RPPB55-F-A	8	50,000	111,10	46,75	7-lip
PER.GW210RPPB55-F-B	8	50,000	111,10	46,75	6-lip
PER.W212RPPB54-F-A	8	60,000	142,90	54,80	6-lip
PER.UCNFT206A-B	9	30,000	116,70	41,80	5-lip
PER.UCNFT206A-A	9	30,000	116,70	41,80	5-lip
PER.W207RPPB61-FT-A	9	35,000	130,20	36,50	6-lip
PER.UCNFT208-A-B	9	40,000	143,70	51,20	5-lip
PER.UCNFT208A-A	9	40,000	143,70	51,20	5-lip
PER.GRNFT206A-A	10	30,000	116,70	44,00	4-lip
PER.UCNFC214A-A	11	70,000	125,00	74,60	5-lip
PER.GFD209RPPB50 ²⁾	12	44,958	127,00	44,37	3-lip LS
PER.GFD211RPPB51-A	12	45,212	98,78	55,56	3-lip LS
PER.GFD211RPPB51	12	45,212	98,78	55,56	3-lip LS
PER.207RRSB-FC-A ¹⁾	–	35,000	70,60	40,00	6-lip

¹⁾ Please contact your SKF representative for details

²⁾ Bolt circle housing



Squared flanged insert bearing unit
Type 1



Round flanged insert bearing unit
Type 2



Roller support bearing unit
Type 3



Flanged disc with square bore, non-relubricatable
Type 4

Designation	Type	Bore/shaft diameter	Fixing dimension square	Width to flange backside	Width	PCD	Seal type
–		mm					–
Seedbed finisher – Insert bearing units							
FY 35 TF	1	35,000	92,0	46,4	–	–	1-lip 2F
FY 40 TF	1	40,000	101,5	54,2	–	–	1-lip 2F
FY 45 TF	1	45,000	105,0	54,2	–	–	1-lip 2F
FY 50 TF	1	50,000	111,0	60,6	–	–	1-lip 2F
FY 50 TR	1	50,000	111,0	60,6	–	–	1-lip RF
FY 60 TF	1	60,000	143,0	73,7	–	–	1-lip 2F
FYC 40 TF	2	40,000	–	–	51,200	120	1-lip 2F
FYC 50 TF	2	50,000	–	–	54,600	138	1-lip 2F
Seedbed finisher – Roller support bearing unit							
PER.UCNTFU312-39AS-A	3	61,912	152,0	78,0	–	–	6-lip
Seedbed finisher – Flanged disc							
PER.RFD209SVVB50	4	29,972	–	–	42,786	127	5-lip



Flanged disc with round bore, non-relubricatable
Type 5



Flanged disc with square bore, non-relubricatable
Type 6



Flanged disc with round bore, relubricatable
Type 7



Flanged disc with square bore, relubricatable
Type 8

Designation	Type	Bore/shaft diameter	Fixing dimension square	Max. width	Seal type
–		mm			–
Seedbed finisher – Flanged disc					
PER.FD209RVVB54	5	32,258	127,0	42,786	5-lip
PER.FD209RVVB52	5	38,989	127,0	42,786	5-lip
PER.FD209RSSB53	5	38,989	127,0	42,786	6-lip
PER.FD209RVVB50	5	44,958	127,0	44,374	5-lip
PER.FD209RVVB58	5	44,958	127,0	42,786	5-lip
PER.FD211RVVB51-A	5	45,212	139,7	55,562	5-lip
PER.FD211RVVB51	5	45,212	139,7	55,562	5-lip
PER.FD211RVVB65	5	49,225	139,7	53,975	5-lip
PER.FD211RVVB61	5	55,575	139,7	55,486	5-lip
PER.FD212RVVB51	5	61,000	202,2	56,000	5-lip
PER.FD209SVVB57	6	29,972	127,0	42,786	5-lip
PER.FD209SVVB51	6	33,020	127,0	42,786	5-lip
PER.FD211SVVB53	6	38,887	139,7	51,000	5-lip
PER.GFD209RPPB52	7	38,989	127,0	42,786	3-lip LS
PER.GFD209RPPB58	7	44,958	127,0	42,786	3-lip LS
PER.GFD209RPPB50	7	44,958	127,0	44,374	3-lip LS
PER.GFD211RPPB51-A	7	45,212	139,7	55,562	3-lip LS
PER.GFD211RPPB65	7	49,225	139,7	53,975	3-lip LS
PER.GFD211RPPB61	7	55,575	139,7	55,486	3-lip LS
PER.GFD209SPPB57	8	29,972	127,0	42,786	3-lip LS
PER.GFD209SPPB51	8	33,020	127,0	42,786	3-lip LS
PER.GFD211SPPB53	8	38,887	139,7	50,800	3-lip LS

Seeding

When the tillage process is complete, it is time for seeding. Seeding opens a narrow furrow in the field for the seed, plants the seeds and then covers them by closing the furrow. These simple steps do though require high precision. Loss of operational precision leads directly to a lower crop yield.

The challenge for the farmer when seeding is to do it quickly but accurately and at the lowest possible cost per hectare. This confirms the importance of selecting the right equipment, which is robust enough to avoid disc wobbling due to high loads, and is properly sealed so as to resist ingress of dirt to achieve a long, reliable service life.

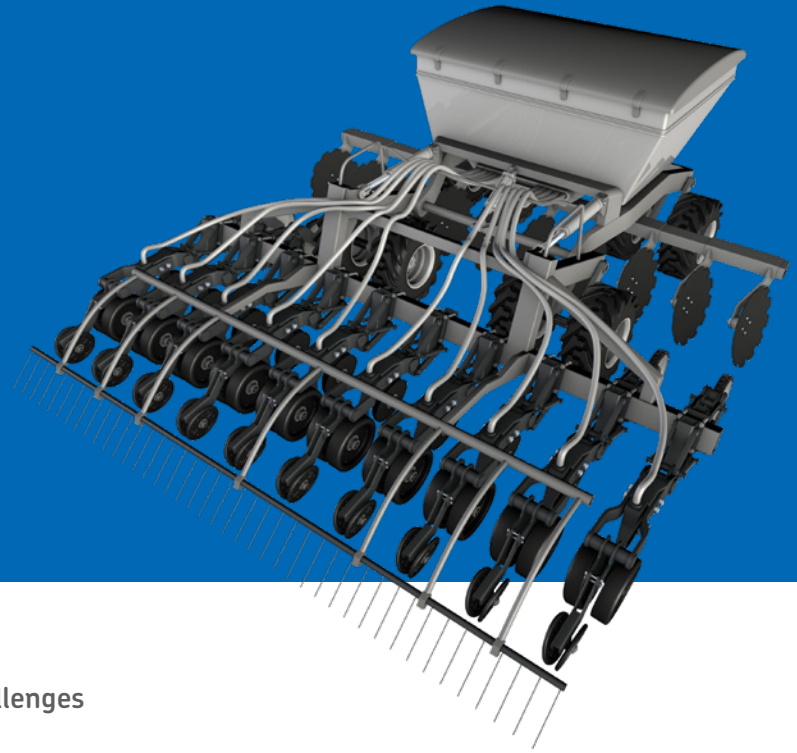

Typical seeding equipment applications

- Opener discs
- Gauge wheels
- Closing discs
- Press wheels, implement wheels, seedmeter drive shafts and row markers

Application challenges

The usage of seeding equipment is very intensive for a limited time and then followed by long periods of inactivity. The intense periods are signified by tough environmental conditions, and sustained work activity. This benefits from the growing conditions prepared during the tillage process. Because of the limited time available for optimal seeding, it is crucial to minimize the downtime during these periods.

Precision is yet again one of the most important factors and is directly connected to and dependent on the reliability of the bearings. The challenge is to maintain precise rotation no matter what the external conditions are.

The consequences of a deficiency in precision or an incorrect seed placement can lead to one or more of the following:

- Insufficient nutrient per seed (if seeds are too close to one another)
- Lower utilization of the field (if seeds are too far from one another)
- Limited aeration and soil resists plant emergence (if seed is too deep)
- Vulnerable to weather, temperature, animals and birds (if seed is too shallow)

The effect can be a reduction in a farmer's yield of up to 60% per season.

Disc opener

Typical conditions for disc opener applications

When opening the furrow, the discs are forced into the soil:

- The bearing assemblies are exposed to mud, dust, crop residues and sometimes stones
- Bearings and discs are subject to high loads

Solutions for disc opener applications

Agri Hubs for seeding are especially designed for seeding applications and opener discs. These are fully integrated units comprising a wide range of flexible designs and are compatible with discs that require external as well as internal mounting. The Agri Hubs for seeding feature a robust five-lip seal which implies that the unit is relubrication-free. Together with steel inserts, this provides good protection of the bearings against solid contaminants such as mud, dust, fibers and water. Through this heavy-duty sealing, the bearing's service life can be increased and at the same time, the need for maintenance and repairs can significantly be reduced.

The integrated bearing is either a four-point contact single or double-row deep groove ball bearing depending on the capacity need. The flexibility of the design also allows to select a hub with a mounting flange made of metal-sheet for additional strength.

Benefits of the SKF Agri Hub

- OEMs
 - Can cut combined warranty, engineering, testing and assembly costs by up to 50%¹⁾
 - Extends bearing unit service life
 - Reduces mounting times and mistakes
 - Differentiates designs
 - Fast delivery worldwide
- End-users
 - Increases bearing unit service life by up to 40%¹⁾
 - Reduces maintenance and ownership costs by up to 20%¹⁾
 - Can be installed or replaced quickly and easily
 - Improves profitability
 - Fast delivery worldwide

Gauge wheel

Typical conditions for gauge wheel applications

- Bearing is assembled in gauge wheel and bolted on machine
- Dusty and sometimes moist environment

Solutions for gauge wheel applications

Benefits and functional features

- Increase productivity and operation life in field due to
 - Optimized internal geometry
 - High load capacity
 - High contamination feature package with exclusive sealing system
- Interchangeable with standard gauge wheel bearings

Press wheel and closing wheel

Typical conditions for press wheel and closing wheel applications

- Press and closing wheel applications perform different functions in the machine but are exposed to similar application conditions; similar bearing solutions are used
- Dusty and sometimes moist environment

Solutions for press wheel and closing wheel applications

Benefits and functional features

- Increase productivity and operation life in field due to
 - Optimized internal geometry
 - High load capacity
 - High contamination feature package with exclusive sealing system

¹⁾ All figures and graphs are rounded off and based on SKF testing against conventional bearings. Savings and results will vary in specific applications.



Agri Hub S100
Type 1



Agri Hub S20
Type 2



Agri Hub S100
Type 3



Agri Hub S50
Type 4



Agri Hub S50/S100
Type 5

Designation	Type	Bore/shaft diameter	Bolt pitch diameter	Holes	Seal type	Performance	Disc diameter
–		mm		–	–	–	mm
Disc opener – Agri Hubs							
PER.HUB16-001	1	16,000	60,0	6	6-lip	S100	up to 360
PER.KITHUB16-001 ¹⁾	1	16,000	60,0	6	6-lip	S100	up to 360
AGHU1675X6H-1LLC	2	16,000	75,0	–	3-lip LS	S20	up to 380
AGHU1675X6H-LC1L	2	16,000	75,0	–	3-lip LS	S20	up to 380
AGHU2075X6H-LC1L	2	20,000	75,0	–	3-lip LS	S20	up to 380
AGHU2075X6F-1LLC	2	20,000	75,0	–	3-lip LS	S20	up to 380
AGHU2075X6H-1LLC	2	20,000	75,0	–	3-lip LS	S20	up to 380
AGHU1675X6H-MB1L	3	16,000	75,0	–	MS	S100	up to 380
AGHU1675X6H-1LMB	3	16,000	75,0	–	MS	S100	up to 380
AGHU2075X6F-1LMB1	3	20,000	75,0	–	MS	S100	up to 380
AGHU2075X6H-MB1L1	3	20,000	75,0	–	MS	S100	up to 380
AGHU2080X6F-1LMB	3	20,000	80,0	–	MS	S100	up to 380
PER.BB204RPS59-FC	3	20,000	79,4	5	6-lip	S100	up to 380
PER.BB204RRY3-FC-A	4	16,053	60,0	–	1-lip	S10	up to 360
PER.HUB16-005	5	16,065	78,0	6	6-lip	S100	up to 380

¹⁾ Item includes additional mounting parts (nuts, washers and screws)



Agri Hub S100
Type 6



Agri Hub S100
Type 7



Agri Hub S100
Type 8



Agri Hub S80
Type 9

Designation	Type	Bore/shaft diameter	Bolt pitch diameter	Holes	Seal type	Performance	Disc diameter
–		mm		–	–	–	mm
Disc opener – Agri Hubs							
PER.5203RSS57-FC	6	17,000	65,0	6	6-lip	S100	up to 380
PER.HUB20-001	7	20,000	80,0	–	6-lip	S100	up to 380
PER.KITHUB20-001 ¹⁾	7	20,000	80,0	5	6-lip	S100	up to 380
PER.HUB20-002	7	20,000	80,0	6	6-lip	S100	up to 380
PER.HUB20-003	7	20,000	80,0	6	6-lip	S100	up to 380
PER.HUB20-004	7	20,000	75,0	6	6-lip	S100	up to 380
PER.HUB20-005	7	20,000	80,0	5	6-lip	S100	up to 380
PER.HUB20-009	8	20,000	127,0	6	6-lip	S100	up to 380
PER.HUB30-007	9	30,000	127,0	4	7-lip	S80	up to 550
PER.HUB30-020	9	30,000	101,6	4	6-lip	S80	up to 550

¹⁾ Item includes additional mounting parts (nuts, washers and screws)



Sealed double row angular contact ball bearing
Type 1



Special bearing
Type 2



Special bearing
Type 3



Double row angular contact ball bearing
Type 4



Special bearing
Type 5



Special bearing
Type 6

Designation	Type	Bore/shaft diameter	Outer diameter	Width outer ring	Width inner ring	Seal type
–		mm				–
Disc Opener – Double row angular contact ball bearing (DRACBB)						
3204 CETN9	4	20,000	47,000	20,600	–	–
3204 CE-2RSH1TN9	1	20,000	47,000	20,600	–	1-lip RSH
3304 CETN9	4	20,000	52,000	22,200	–	–
3304 CE-2RSH1TN9	1	20,000	52,000	22,200	–	1-lip RSH
PER.5204-2RSW	1	20,000	47,000	20,638	–	1-lip
Disc opener – Special bearings						
PER.BB203RRR5	3	13,061	40,000	12,000	18,288	1-lip
PER.WBB205RPP62	3	14,500	53,086	18,200	29,150	3-lip LS
PER.203RRR9	6	15,900	40,000	12,954	12,954	1-lip R
PER.204RRR4 ¹⁾	3	16,027	47,000	14,000	17,500	1-lip R
PER.5204RRY2	2	16,027	45,225	22,820	26,000	2-lip / 1-lip F
PER.BB205RRP2-A	3	16,030	52,000	15,000	17,983	3-lip LS / 1-lip R
PER.BB204RRY3-A	3	16,053	45,225	15,494	18,669	2-lip
PER.BB204RRY3-D	3	16,053	45,225	15,494	18,669	2-lip / 1-lip R
PER.BB204RRP3	3	16,053	45,225	15,494	18,669	3-lip LS / 1-lip F
PER.5204RRF57-A	5	16,100	47,000	16,100	22,100	4-lip

¹⁾ Flush inner ring

Special bearing
Type 7Special bearing
Type 8Special bearing
Type 9Special bearing
Type 10Special bearing
Type 11

Designation	Type	Bore/shaft diameter	Outer diameter	Width outer ring	Width inner ring	Seal type
–		mm				–
Disc opener – Special bearings						
PER.5204RRP51	7	16,129	47,000	26,000	29,175	3-lip LS / 1-lip F
PER.5204RRP50	10	16,129	47,000	28,000	28,000	3-lip LS / 1-lip F
PER.BB304RPP50	8	16,129	53,086	18,260	24,608	3-lip LS
PER.WBB205RPP60-A	11	16,129	53,086	18,263	19,430	3-lip LS
PER.BB205RPP13	11	16,129	53,086	19,430	18,260	3-lip LS
PER.5204RPP55	9	16,250	47,000	39,120	44,120	3-lip LS
PER.BB203RYY2-B	8	16,256	40,000	12,000	18,288	1-lip
PER.203RYY2	8	16,256	40,000	12,000	18,288	2-lip
PER.5203RPP2-A	9	16,256	40,000	39,120	44,120	3-lip LS
PER.205RP8	8	19,200	52,000	15,000	18,288	3-lip LS / none
PER.205RRP2	8	19,202	52,000	15,000	21,107	3-lip LS / 1-lip R
PER.BB205RRP2	8	19,202	52,000	15,000	21,107	3-lip LS / 1-lip R
PER.W5204RP52-D	7	20,000	47,000	21,900	25,200	3-lip LS
PER.5204RRP52	7	20,000	47,000	23,000	26,300	3-lip LS / 1-lip RS1
PER.W5204-2RSTFPC3G6	10	20,000	47,000	23,812	23,812	1-lip F
PER.205RRP5	8	20,000	52,000	15,000	21,107	3-lip LS / 1-lip R
PER.206RRP4	8	25,146	62,000	18,000	22,225	3-lip LS / 1-lip R
PER.206RRP50	8	30,000	62,000	18,000	22,225	3-lip LS / 1-lip R
PER.5206RPP3	9	30,150	62,000	37,000	50,000	3-lip LS



Special bearing
Type 1



Special bearing
Type 2



Special bearing
Type 3



Special bearing
Type 4



Special bearing
Type 5



Special bearing
Type 6

Designation	Type	Bore/shaft diameter	Outer diameter	Width outer ring	Width inner ring	Seal type
–		mm				–
Gauge wheel – Special bearings						
PER.5203RRR2	1	16,256	40,000	39,120	44,120	1-lip G
PER.5203RSS2-A	1	16,256	40,000	39,120	44,120	6-lip
PER.5203-ZZW	1	17,000	40,000	17,463	17,463	Double shielded
PER.WP5203NRP2	2	15,660	30,000	69,000	38,800	3-lip LS
Press wheel / Closing wheel – Special bearings						
PER.5203RYY2	1	16,256	40,000	39,120	44,120	2-lip
PER.5203RSS2	1	16,256	40,000	39,120	44,120	6-lip
PER.5203RPP52	1	16,800	40,000	39,120	44,120	3-lip LS
PER.5203RPP52-A	1	16,800	40,000	39,120	44,120	3-lip LS
PER.5203RPP54	3	16,256	40,000	39,120	72,000	3-lip LS
PER.203RRR9	4	15,900	40,000	12,954	12,954	1-lip R
PER.BB203RRR5	5	13,061	40,000	12,000	18,288	1-lip R
PER.BB203RYY50	5	13,081	40,000	12,000	18,288	2-lip
PER.BB203RYY2-B	5	16,256	40,000	12,000	18,288	2-lip
PER.BB203RRR2	5	16,256	40,000	12,000	18,288	1-lip R
PER.BB203RYY2	5	16,256	40,000	12,000	18,288	2-lip
PER.203RRY61	5	17,000	40,000	12,000	14,000	2-lip / 1-lip R
PER.W5203RYY59	6	16,129	40,000	17,463	24,500	2-lip
PER.W5203RRF58	6	17,000	40,000	24,300	30,500	4-lip / 1-lip RS1
PER.5204RP52-A	6	20,000	47,000	21,900	25,200	3-lip LS
PER.5204RPP53	6	20,000	47,000	39,120	44,120	3-lip LS
PER.W5204RRY62	6	20,000	45,255	22,820	26,000	2-lip / 1-lip F
PER.5206RRP50	6	22,150	62,000	37,000	37,000	3-lip LS / 1-lip F
PER.5208RSS50 ¹⁾	6	38,113	80,000	47,000	47,000	6-lip

¹⁾ Flush inner ring

Special unit
Type 7Special bearing
Type 8Special unit
Type 9Special bearing
Type 10Special bearing
Type 11Special bearing
Type 12

Designation	Type	Bore/shaft diameter	Outer diameter	Width outer ring	Width inner ring	Seal type
–		mm				–
Seedmeter – Special bearings and units						
PER.5203NYY50	7	15,850	40,000	25,400	30,400	2-lip
Seedmeter drive shaft – Special bearings and units						
PER.205RR3	8	19,075	52,000	17,780	16,256	1-lip G
PER.205HPPB2-2BF	9	22,250	80,980	15,000	25,400	3-lip LS
PER.204HRR2-C	10	17,653	47,000	14,000	20,955	1-lip G
PER.206HRR52-A	10	22,700	62,000	16,000	22,000	1-lip G
PER.W204HRRB2	11	17,653	47,000	14,000	20,955	1-lip R
PER.205HPPB54	11	22,250	52,000	15,000	22,936	3-lip LS
PER.205HRRB2	11	22,250	52,000	15,000	25,400	1-lip G
PER.205HPPB2-A	11	22,250	52,000	15,000	25,400	3-lip LS
PER.204HYY2	12	17,653	47,000	14,000	20,955	2-lip
PER.204HZZ2	12	17,653	47,000	14,000	20,955	Double shielded
PER.205HRR2	12	22,250	52,000	15,000	25,400	1-lip G
PER.205HPP2	12	22,250	52,000	15,000	25,400	3-lip LS
PER.206HPP3	12	30,150	62,000	37,000	50,000	3-lip LS

Harvesting

Harvest season is hard, and a machinery breakdown at this crucial time can endanger a full season of hard work. Combine harvesters are amongst the most complex of farming machines; reliant on many sub-systems to achieve the harvesting, threshing and winnowing of the crop and final unloading of the grain.



Combine harvester

Application challenges

After sitting idle for months, harvesters are put through grueling, round-the-clock schedules. If crop debris, dirt and water work their way into critical components, their service life is substantially reduced.

Challenges include:

- Crop particle and other solid contaminant ingress
- Wash-downs
- Task time criticality, machine availability

If the bearings and seals are not designed for these kinds of conditions, it can easily lead to damage and early life failure. Such events can lower productivity, significantly increase maintenance costs and reduce overall profitability.

Typical conditions for combine harvester applications

- Operates with constant exposure to heavy dust and crop contact
- Subject to static misalignment due to imprecise mounting surfaces

Solutions for combine harvester applications

Among the many products especially developed to handle harsh conditions, SKF offers insert bearing units (relubrication-free, quick and easy to mount), a range of radial ball and roller bearings, seals and lubrication systems. For applications where the contamination risk is high, SKF agricultural insert bearing units with their relubrication-free design and increased service life can help to:

- Reduce maintenance and ownership costs
- Keep grease from contaminating the grain

SKF insert bearing units incorporate high performance sealing solutions that have been tested and proven under farm conditions. Appropriate to the precise application, the insert bearing range includes bearings as well as bearings and housings. Both are available with seals optimized for the application and the contamination level in that specific environment. The unitized nature of these designs means fewer separate components, allowing a plug and play approach for quick and easy mounting.

SKF has also developed a specific range of deep groove ball bearings for positions with limited space not allowing an SKF insert bearing assembly or for higher rotating speeds with tight press-fit on shaft and/or housing. They feature a high performance sealing and specific grease for harsh agricultural conditions. This range is identified with an AAG-VA387 suffix (e.g. 6206-2RS1/AAG-VA387).



Disc mower

As disc mowers cut and prepare hay for drying, unplanned stops for maintenance or repairs means lost production. Too often, conventional bearing and sealing arrangements enable such losses by allowing gear particles or other contaminants to enter the bearings. Lubricant loss, bearing failures and costly breakdowns can follow, causing risks to operator safety and the bottom line.

Solutions for disc mower applications

Designed to be more productive and easier to maintain, robust seal designs and relubrication-free bearing units from SKF can help prevent unplanned downtime. SKF solutions have been tested to withstand heavy vibration and harsh field conditions. Integrated and compact, they also help OEMs reduce components and speed up assembly.



Baling

The process of converting windrows of crop into bales, necessitates the pickup of crop, compacting and wrapping inside the bale chamber and ejection of the completed bale. Much of this processing relies on rollers and for a square baler, a reciprocating plunger, so multiple bearings are required to produce an effective as well as a precise baling process.

Application challenges

Baling can impose heavy loads on the machine components, which is why it is essential that the bearings can sustain these stresses. It is also of great importance that at the same time, the bearings can exclude dust and crop wrap to minimize the time required for maintenance and service.

- Many bearings exposed to heavy loads
- Dust and crop wrap
- Improving precision, and bale quality
- Increasing productivity

If the support bearings are not designed for these kinds of conditions, it can easily lead to damage and early life failure. Such events can lower productivity, increase maintenance costs and reduce overall profitability.

Typical conditions for baler applications

Operates with exposure to crop wrap and dust, in dry hay conditions and with higher moisture conditions when baling silage.

Solutions for baler applications

Among the many products especially developed to handle harsh conditions, SKF offers its insert bearings (relubrication-free, quick and easy to mount), a range of radial ball and roller bearings, and seals. For applications where the contamination risk is high, SKF agricultural insert bearing units with their relubrication-free design and increased service life can help to:

- Reduce maintenance and ownership costs
- Keep grease from contaminating crops, soil, or groundwater supplies

Typical conditions for pick-up assembly applications

The pick-up assembly rakes the hay from the windrow into the baling chamber. Tine bar, pickup drum and cam follower are all part of the pickup subassembly.

- The tine bar rakes the hay off the field into the baling chamber
- The cam follower creates a flipping action to the tine bar to deposit the hay into the baling chamber
- The pick-up drum rotates and supports multiple tine bars creating a raking action

Solutions for pick-up assembly applications

Bearings for pick-up applications are designed for impact and long wear life in the case of cam followers and robust seals for tine bar and pick-up drum positions.



Double row angular contact ball bearing
Type 1



Special Bearing
Type 2



Special bearing
Type 3

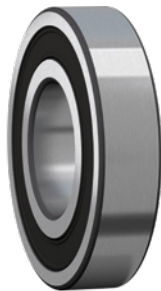

Deep groove ball bearing
Type 4



Insert bearing
Type 5



Mounted unit
Type 6

Designation	Type	Bore / shaft diameter	Bore type	Outer diameter	Seal type
–		mm	–	mm	–
Head – Double row angular contact ball bearing (DRACBB)					
3201 ATN9 ¹⁾	1	12,000	Round	32,0	–
3204 CE-2RS1TN9/C3 ¹⁾	1	20,000	Round	47,0	1-lip RS1
3214 A ¹⁾	1	70,000	Round	125,0	–
PER.W5207HRRB60 ²⁾	1	31,750	Hexagonal	72,0	1-lip G
PER.W5207RRRB60-A	1	31,750	Hexagonal	72,0	1-lip G
PER.GW5209HYYB2 ²⁾	1	38,200	Hexagonal	85,0	2-lip
Head – Insert and special bearings					
PER.203RPP50 ¹⁾	2	16,256	Round	40,0	3-lip LS
PER.203RRR2 ¹⁾	2	16,256	Round	40,0	1-lip R
PER.203RRR2-G ¹⁾	2	16,256	Round	40,0	1-lip R
PER.203RRR2-B ¹⁾	2	16,256	Round	40,0	1-lip G
PER.FH206-18A	5	28,575	Round	62,0	1-lip F
PER.204HRR2 ¹⁾	3	17,653	Hexagonal	47,0	1-lip G
PER.204HRR2-B ¹⁾	3	17,653	Hexagonal	47,0	1-lip G
PER.BB204HYY2 ¹⁾	3	17,653	Hexagonal	47,0	2-lip
PER.206HRRB6	3	25,425	Hexagonal	62,0	1-lip R
PER.207HRRB9	3	28,600	Hexagonal	72,0	1-lip G
Head – Deep groove ball bearing (DGBB)					
6304-2RSH	4	20,000	Round	52,0	1-lip RSH
6015-2RS1	4	75,000	Round	115,0	1-lip RS1
Head – Mounted unit					
PER.207HPPB57-FT	6	31,775	Hexagonal	130,2	3-lip LS

¹⁾ Cylindrical outside diameter
²⁾ Spherical outside diameter



Special bearing
Type 7



Insert bearing
Type 8



Sealed spherical roller bearing
Type 9



Spherical roller bearing
Type 10

Designation	Type	Bore/shaft diameter	Bore type	Outer diameter	Seal type
–		mm	–	mm	–
Feederhouse / Rotor – Spherical roller bearings					
BS2-2206-2RS/VT143	9	30,000	Round	62	1-lip RS1
BS2-2207-RS/VT143	9	35,000	Round	72	1-lip RS1
22208 E	10	40,000	Round	80	–
BS2-2208-2RS/VT143	9	40,000	Round	80	1-lip RS1
BS2-2208-2RSW/GEM9	9	40,000	Round	80	2RSW ¹⁾
BS2-2212-2RS/VT143	9	60,000	Round	110	1-lip RS1
Feederhouse / Rotor – Insert and special bearings					
PER.W208HPPB16	7	31,780	Hexagonal	80	3-lip LS
PER.210HPPB20	10	31,877	Hexagonal	90	3-lip LS
PER.209HRRB2	7	38,100	Hexagonal	85	1-lip G
PER.FH208-40MMA	8	40,000	Round	80	1-lip F
PER.W211HRRB50	7	44,475	Hexagonal	100	1-lip G

¹⁾ Two seals and no W33 groove – With no lubrication holes in outer ring



Cylindrical bearing with flush inner ring
Type 1



Spherical bearing with wide inner ring
Type 2



Insert bearing
Type 3

Designation	Type	Bore/shaft diameter	Bore type	Outer diameter	Seal type
–		mm	–	mm	–
Clean Grain / Residue - Insert and special bearings					
PER.203RRR5-A	5	13,081	Round	40,000	1-lip R
PER.202HRR3	1	14,300	Hexagonal	35,000	1-lip G
PER.205RPP10	5	16,030	Round	52,000	3-lip LS
PER.203RRR6	5	16,256	Round	47,000	1-lip R
PER.205RPP9	5	19,202	Round	52,000	3-lip LS
PER.FH205-14A ¹⁾	3	22,225	Round	52,000	1-lip F
PER.205HPPB2	2	22,250	Hexagonal	52,000	3-lip LS
PER.205RPPB7	6	23,813	Round	52,000	3-lip LS
PER.FH205A ¹⁾	3	25,000	Round	52,000	1-lip F
PER.HCN205A	3	25,000	Round	52,000	1-lip G
PER.UCN205A	4	25,000	Round	52,000	1-lip G
YEL 205-2DW/AG	3	25,000	Round	52,000	3-lip HS
YAR 205-2DW/AG	4	25,000	Round	52,000	3-lip HS
PER.FH205-16A ¹⁾	3	25,400	Round	52,000	1-lip F
PER.HC205-16A-A	3	25,400	Round	52,000	1-lip G
YEL 205-100-2DW/AG	3	25,400	Round	52,000	3-lip HS
PER.206HRR6	1	25,425	Hexagonal	62,000	1-lip R
PER.206HPPB5	2	25,425	Hexagonal	62,000	3-lip LS
PER.G206HPPB4	2	25,425	Hexagonal	62,000	3-lip LS
PER.G207HRR28	1	27,559	Hexagonal	78,054	1-lip R
PER.FH206-18A ¹⁾	3	28,575	Round	62,000	1-lip F
YEL 206-102-2DW/AG	3	28,575	Round	62,000	3-lip HS
PER.208HPPB52	2	28,600	Hexagonal	80,000	3-lip LS
PER.207HRRB58	2	28,600	Hexagonal	72,000	1-lip G
PER.FH206A ¹⁾	3	30,000	Round	62,000	1-lip F
PER.HC206A	3	30,000	Round	62,000	1-lip G
PER.UCN206A	4	30,000	Round	62,000	1-lip G
YEL 206-2DW/AG	3	30,000	Round	62,000	3-lip HS
YAR 206-2DW/AG	4	30,000	Round	62,000	3-lip HS
PER.206RP2	5	30,000	Round	62,000	3-lip LS
PER.FH206-19A ¹⁾	3	30,162	Round	62,000	1-lip F
YEL 206-103-2DW/AG	3	30,162	Round	62,000	3-lip HS
PER.FH206-20A ¹⁾	3	31,750	Round	62,000	1-lip F
PER.FH207-20A ¹⁾	3	31,750	Round	72,000	1-lip F
PER.HCN207-20A-A	3	31,750	Round	72,000	1-lip G
YEL 207-104-2DW/AG	3	31,750	Round	72,000	3-lip HS
PER.207RRR14	1	31,826	Round	72,000	1-lip R

¹⁾ Flush inner ring



Insert bearing
Type 4



Cylindrical bearing with flush inner ring
Type 5



Spherical bearing with flush inner ring
Type 6

Designation	Type	Bore/shaft diameter	Bore type	Outer diameter	Seal type
–		mm	–	mm	–
Clean Grain/Residue –Insert and special bearings					
PER.FH207-22A ¹⁾	3	34,925	Round	72	1-lip F
PER.FHR207-22A ¹⁾	3	34,925	Round	72	1-lip F
PER.HC207-22A-B	3	34,925	Round	72	1-lip G
YEL 207-106-2DW/AG	3	34,925	Round	72	3-lip HS
PER.FH207A-B ¹⁾	3	35,000	Round	72	1-lip F
PER.HCN207A	3	35,000	Round	72	1-lip G
PER.UCN207A	4	35,000	Round	72	1-lip G
PER.207RRR3	1	35,000	Round	72	1-lip G
YEL 207-DW/AG	3	35,000	Round	72	3-lip HS
YAR 207-DW/AG	4	35,000	Round	72	3-lip HS
PER.FH207-23A ¹⁾	3	36,512	Round	72	1-lip F
YEL 207-107-2DW/AG	3	36,512	Round	72	3-lip HS
PER.HC207-23A-A	3	36,513	Round	72	1-lip G
PER.FH208-24AF-A	3	38,100	Round	80	1-lip F
PER.HCN208-24A-A	3	38,100	Round	80	1-lip G
YEL 208-108-2DW/AG	3	38,100	Round	80	3-lip HS
PER.FH208-40MMA	3	40,000	Round	80	1-lip F
PER.HCN208A	3	40,000	Round	80	1-lip G
PER.UCN208A	4	40,000	Round	80	1-lip G
YEL 208-2DW/AG	3	40,000	Round	80	3-lip HS
YAR 208-2DW/AG	4	40,000	Round	80	3-lip HS
PER.HC209-26A	3	41,275	Round	85	1-lip G
YEL 209-111-2DW/AG	3	42,862	Round	85	3-lip HS
PER.FH209-28A	3	44,450	Round	85	1-lip F
PER.HC209-28A	3	44,450	Round	85	1-lip G
YEL 209-112-2DW/AG	3	44,450	Round	85	3-lip HS
PER.FH209A	3	45,000	Round	85	1-lip F
PER.HCN209-A	3	45,000	Round	85	1-lip G
PER.UCN209A	4	45,000	Round	85	1-lip G
YEL 209-2DW/AG	3	45,000	Round	85	3-lip HS
YAR 209-2DW/AG	4	45,000	Round	85	3-lip HS

¹⁾ Flush inner ring

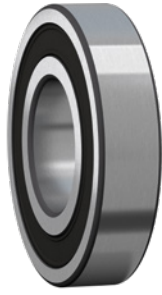

Deep groove ball bearing
Type 1



Sealed spherical roller bearing
Type 2

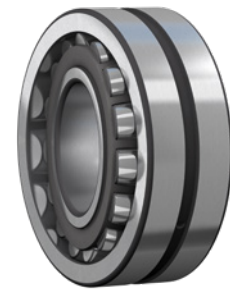

Spherical roller bearing
Type 3

Designation	Type	Bore/shaft diameter	Bore type	Outer diameter	Seal type
–		mm	–	mm	–
Clean Grain/Residue – Spherical roller bearings					
BS2-2210-2RS/VT143	2	50	Round	90	1-lip RS1
22211 E	3	55	Round	100	–
22213 E/C3	3	65	Round	120	–
Clean Grain/Residue – Deep groove ball bearing					
6012-2RS1	1	60	Round	95	1-lip RS1
6218-2RS1	1	90	Round	160	1-lip RS1
6020-2RS1	1	100	Round	150	1-lip RS1



Mounted unit
Type 4



Mounted unit
Type 5

Designation	Type	Bore/shaft diameter	Housing material	Number of holes	Housing shape	Bolt spacing	Seal type
–		mm	–	–	–	mm	–
Clean Grain/Residue – Mounted units							
FYTBK 20 WD	4	20,000	Composite	2	Oval	90,0	3-lip HS
FYTBK 25 WD	4	25,000	Composite	2	Oval	99,0	3-lip HS
FYTBK 30 WD	4	30,000	Composite	2	Oval	116,5	3-lip HS
FY 2.7/16 TF	5	61,913	Grey cast iron	4	Square	143,0	1-lip 2F



Deep groove ball bearing
Type 1

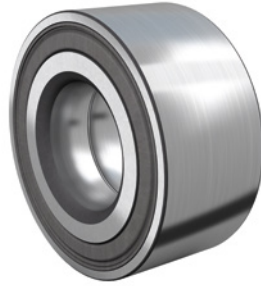

Agri Hub M100
Type 2

Designation	Type	Bore/shaft diameter	Bore type	Outer diameter	Seal type
–		mm	–	mm	–
Disc/blade – Deep groove ball bearing (DGBB)					
6207-2RS1	1	35	Round	72,000	1-lip RS1
6207-2RSH	1	35	Round	72,000	1-lip RSH
6307-2RS1	1	35	Round	80,000	1-lip RS1
6307-2RSH	1	35	Round	80,000	1-lip RSH
Disc/blade – Agri Hub					
BAH-0013 E	2	35	Round	72,043	CS ¹⁾
BAH-0013 D	2	35	Round	72,043	CS
BAH-0013 AB	2	35	Round	72,043	CS ²⁾

¹⁾ Low friction seal
²⁾ Oil seal

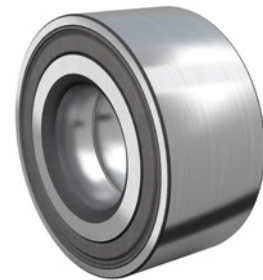
Special bearing
Type 3Special bearing
Type 4Special bearing
Type 5Special bearing
Type 6Special bearing
Type 7Agri Hub M100
Type 8

Designation	Type	Bore/shaft diameter	Bore type	Outer diameter	Seal type
–		mm	–	mm	–
Pick-up – Special bearing					
PER.CF5002NYY8	3	12,700	Integral bolt	38,1	2-lip
PER.CF5202RYY	4	12,700	Round	38,1	2-lip
PER.CF202RRR9	4	12,827	Round	38,1	1-lip R
PER.FHR6005-XD-A	5	27,280	Round	47,0	1-lip R
PER.FHR6005-XD-D	6	27,280	Round	47,0	1-lip R
PER.207HRRB12	7	28,600	Hexagonal	72,0	1-lip G
PER.207HRRB17	7	31,775	Hexagonal	72,0	1-lip G
Pick-up – Agri Hub					
BAH-0069	8	42,000	Round	78,0	CS



Mounted unit
Type 1



Special mounted unit
Type 2



Special mounted unit
Type 3



Mounted unit
Type 4

Designation	Type	Bore/shaft diameter	Housing material	Number of holes	Housing shape	Bolt spacing	Seal type
–		mm	–	–	–	mm	–

Round baler – Mounted units

PER.HCF3X206ATN-A	1	30,000	Ductile Cast	3	Triangle	90,5	3-lip LS
PER.GW208HPPB50-F4X ¹⁾	2	31,775	Ductile Cast	4	Square	119,1	3-lip LS
PER.GW210HPPB50-F4X ¹⁾	2	44,475	Ductile Cast	4	Square	127,0	3-lip LS
PER.GW211HPPB51-FS	3	44,475	Grey Cast Iron	4	Square	130,2	3-lip LS
PER.HCFS310A-A	4	50,000	Grey Cast Iron	4	Square	130,2	1-lip G

¹⁾ Bolt spacing is diameter of bolt circle

Special bearing
Type 5Special bearing
Type 6Insert bearing
Type 7Special bearing
Type 8Deep groove ball bearing
Type 9Insert bearing
Type 10

Designation	Type	Bore/shaft diameter	Bore type	Outer diameter	Seal type
–		mm	–	mm	–
Round baler – Insert and special bearings					
PER.205RY3 ¹⁾	5	19,050	Round	52	2-lip
PER.206RPP16 ¹⁾	5	19,177	Round	62	3-lip LS
PER.206RRR14 ¹⁾	5	31,773	Round	62	1-lip G
PER.207HPPB55	8	31,775	Hexagonal	72	3-lip LS
PER.W208HPP21 ¹⁾	8	31,775	Hexagonal	80	3-lip LS
PER.GW208HPPB50	8	31,775	Hexagonal	80	3-lip LS
PER.GW208HPPB22	8	31,877	Hexagonal	80	3-lip LS
PER.210HPP20 ¹⁾	8	31,877	Hexagonal	90	3-lip LS
PER.GW208HPPB29	8	31,877	Hexagonal	80	3-lip LS
PER.W208HYYB60	8	31,877	Hexagonal	80	2-lip
PER.W208HRRB6	8	34,950	Hexagonal	80	1-lip G
PER.CF6007RPP51	6	35,000	Round	72	3-lip LS
PER.W208RPP53 ¹⁾	5	38,100	Round	80	3-lip LS
PER.W208RPPB10	5	38,113	Round	80	3-lip LS
PER.W215HPP52 ¹⁾	8	38,250	Hexagonal	130	3-lip LS
PER.208RRR4 ¹⁾	5	38,892	Round	80	1-lip G
PER.GW210HPPB50	8	44,475	Hexagonal	90	3-lip LS
PER.GW211HPPB51	8	44,475	Hexagonal	100	3-lip LS
PER.W312HPP51 ¹⁾	8	44,602	Hexagonal	130	3-lip LS
Round baler – Deep groove ball bearing (DGBB)					
6307-2RS1	9	35,000	Round	80	1-lip RS1
6211-2RS1/C3	9	55,000	Round	100	1-lip RS1
Round baler – Insert bearings					
PER.FHR208-24A ¹⁾	10	38,100	Round	80	1-lip F
PER.UCR208-24AT-A	7	38,100	Round	80	1-lip G
PER.UCR212-39AT-A	7	61,912	Round	110	3-lip LS

¹⁾ Cylindrical outside diameter



Special bearing
Type 1



Special bearing
Type 2



Special bearing
Type 3



Special bearing
Type 4

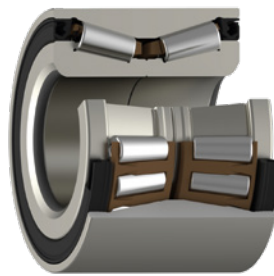

Hub bearing unit (HBU1T)
Type 5



Spherical roller bearing
Type 6

Designation	Type	Bore / shaft diameter	Bore type	Outer diameter	Seal type
–		mm	–	mm	–
Square baler – Special bearing					
BBY-0076	1	6,350	Round	31,50	2-lip
BBY-0083	1	6,350	Round	31,50	2-lip
PER.TG1603RRR50-A	1	6,477	Round	31,75	1-lip G
PER.CF203RRR3-B	2	15,951	Round	50,80	1-lip F
PER.CF6901NY	3	19,050	Integral bolt (long)	63,50	2-lip
PER.CF6901NY-A	3	19,050	Integral bolt (short)	63,50	2-lip
PER.205RYY3	2	19,202	Round	63,50	2-lip
PER.208RRRB5	4	36,525	Round	80,00	1-lip F
Square baler – Hub bearing unit tapered first generation (HBU1T)					
BTHB1866046ACQ	5	41,000	Round	68,00	CS
Square baler – Spherical roller bearing (SRB)					
22213 E	6	65,000	Round	120,00	–
23220 CC/W33	6	100,000	Round	180,00	–

Attachments and trailer wheels

Implement wheel and walking beam of tillage and seeding machines

Aside from the tillage or seeding discs themselves, multiple bearings are used to mount implement wheels and to provide walking beam support structures.

Application challenges

Implements and attachments come in a variety of shapes and sizes, but what they have in common is that the associated bearings must tolerate harsh working environments. Some of the challenges faced include:

- Combined radial and axial loads
- Shock loading
- Higher machine speeds (for higher productivity)

If the bearings and seals are not designed for these kinds of conditions, it can easily lead to damage and early life failure. Such events lower productivity, significantly increase maintenance costs and reduce overall profitability.

Solutions for attachments and trailer wheels

For implement wheel and walking beam support, SKF offers a range of single row tapered roller bearings. In these applications, the bearings are used in opposing pairs and are designed to accommodate combined loads (simultaneous radial and axial).



Designation	Inner diameter (d)	Outer diameter (D)	Total width (T)	Width cup (C)	Width cone (B)
–	mm				
Implement wheel and walking beam – Tapered roller bearings					
PER.LM11949/10	19,050	45,237	15,494	12,065	16,637
PER.LM12749/10	21,986	45,237	15,494	12,065	16,637
PER.L44643/10	25,400	50,292	14,224	10,668	14,732
PER.L44649/10	26,988	50,292	14,224	10,668	14,732
PER.LM67048/10	31,750	59,131	15,875	11,811	16,764
PER.15123 and PER.15250	31,750	63,500	18,161	16,875	19,050
PER.15126 and PER.15250	31,750	63,500	20,637	16,875	20,638
PER.2790/20	33,338	76,200	23,812	19,050	25,654
PER.LM48548/10	34,925	65,088	18,034	13,970	18,288
PER.25877 and PER.25821	34,925	73,025	23,812	19,050	24,608
PER.68149/11	34,988	59,974	15,875	11,938	16,764
PER.30207	35,000	72,000	18,250	15,000	17,000
PER.JL69349/10	38,000	63,000	17,000	13,500	17,000
PER.LM29749/10	38,100	65,088	18,034	13,970	18,288
PER.LM501349/10	41,275	73,431	19,558	14,732	19,812
PER.342A-A and PER.332	41,275	80,000	28,575	17,828	29,977
PER.25580/20	44,450	82,931	23,812	19,050	25,400
PER.HM803149/10	44,450	88,900	30,162	23,020	29,370
PER.460 and PER.453A	44,450	107,950	30,162	22,225	29,317
PER.33109	45,000	80,000	26,000	20,500	26,000
PER.LM102949/10	45,242	73,431	19,558	15,748	19,812
PER.LM603049/11	45,242	77,788	19,842	15,080	19,842
PER.25590/20	45,618	82,931	23,812	19,050	25,400
PER.JLM 104948 and PER.JLM 104910	50,000	82,000	21,500	17,000	21,500
PER.LM104949/11	50,800	82,550	21,116	16,510	22,225
PER.3780/20	50,800	93,264	30,162	23,812	30,302
PER.33889 and PER.33821	50,800	95,250	27,783	22,225	28,575
PER.JLM506849/10	55,000	90,000	23,000	18,500	23,000
PER.387AS and PER.382A	57,150	96,838	21,000	15,875	21,946
PER.45289 and PER.45220	57,150	104,775	30,162	23,812	30,958
PER.39585 and PER.39520	63,500	112,712	30,162	23,812	30,162
PER.HM212049/11	66,675	122,238	38,100	29,718	38,354
PER.HM218248 and PER.HM218210	89,974	146,975	40,000	32,500	40,000



Industry designation	SKF designation	Part Marking	Page
12x22x7 CRW1 R	12x22x7 CRW1 R	12x22x7 CRW1 R	19
14x24x7 HMSA10 RG	14x24x7 HMSA10 RG	14x24x7 HMSA10 RG	19
15x24x7 HMSA10 RG1	15x24x7 HMSA10 RG1	15x24x7 HMSA10 RG1	19
15x35x7 HMSA10 RG	15x35x7 HMSA10 RG	15x35x7 HMSA10 RG	19
15x35x7 CRW1 R	15x35x7 CRW1 R	15x35x7 CRW1 R	19
17x40x7 HMSA10 RG	17x40x7 HMSA10 RG	17x40x7 HMSA10 RG	19
20x30x7 HMSA10 RG	20x30x7 HMSA10 RG	20x30x7 HMSA10 RG	19
20x35x7 HMSA10 RG	20x35x7 HMSA10 RG	20x35x7 HMSA10 RG	19
20x35x7 HMS5 RG	20x35x7 HMS5 RG	20x35x7 HMS5 RG	19
20x40x7 HMSA10 RG	20x40x7 HMSA10 RG	20x40x7 HMSA10 RG	19
20x47x7 HMSA10 RG	20x47x7 HMSA10 RG	20x47x7 HMSA10 RG	19
25x35x7 HMSA10 RG	25x35x7 HMSA10 RG	25x35x7 HMSA10 RG	19
25x35x7 HMS5 RG	25x35x7 HMS5 RG	25x35x7 HMS5 RG	19
25x37x7 HMSA10 RG	25x37x7 HMSA10 RG	25x37x7 HMSA10 RG	19
25x38x7 HMSA10 RG	25x38x7 HMSA10 RG	25x38x7 HMSA10 RG	19
25x40x7 HMSA10 RG	25x40x7 HMSA10 RG	25x40x7 HMSA10 RG	19
25x47x7 HMSA10 RG	25x47x7 HMSA10 RG	25x47x7 HMSA10 RG	19
25x47x7 HMS5 RG	25x47x7 HMS5 RG	25x47x7 HMS5 RG	19
25x52x7 HMSA10 RG	25x52x7 HMSA10 RG	25x52x7 HMSA10 RG	19
30x40x7 HMSA10 RG	30x40x7 HMSA10 RG	30x40x7 HMSA10 RG	19
30x40x7 HMS5 RG	30x40x7 HMS5 RG	30x40x7 HMS5 RG	19
30x45x8 CRW1 R	30x45x8 CRW1 R	30x45x8 CRW1 R	19
30x47x7 HMSA10 RG	30x47x7 HMSA10 RG	30x47x7 HMSA10 RG	19
30x47x7 CRW1 R	30x47x7 CRW1 R	30x47x7 CRW1 R	19
30x52x7 HMSA10 RG	30x52x7 HMSA10 RG	30x52x7 HMSA10 RG	19
30x62x7 HMSA10 RG	30x62x7 HMSA10 RG	30x62x7 HMSA10 RG	19
35x47x7 HMSA10 RG	35x47x7 HMSA10 RG	35x47x7 HMSA10 RG	19
35x47x7 HMS5 RG	35x47x7 HMS5 RG	35x47x7 HMS5 RG	19
35x52x7 HMSA10 RG	35x52x7 HMSA10 RG	35x52x7 HMSA10 RG	19
35x52x7 HMS5 RG	35x52x7 HMS5 RG	35x52x7 HMS5 RG	19
35x55x10 HMSA10 RG	35x55x10 HMSA10 RG	35x55x10 HMSA10 RG	19
35x58x10 HMSA10 RG	35x58x10 HMSA10 RG	35x58x10 HMSA10 RG	19
35x62x7 HMS5 RG	35x62x7 HMS5 RG	35x62x7 HMS5 RG	19
35x72x8 CRW1 R	35x72x8 CRW1 R	35x72x8 CRW1 R	19
35x72x10 HMSA10 RG	35x72x10 HMSA10 RG	35x72x10 HMSA10 RG	19
38x52x7 HMSA10 RG	38x52x7 HMSA10 RG	38x52x7 HMSA10 RG	19
40x52x7 HMSA10 RG	40x52x7 HMSA10 RG	40x52x7 HMSA10 RG	20
40x55x7 HMS5 RG	40x55x7 HMS5 RG	40x55x7 HMS5 RG	20
40x62x7 HMSA10 RG	40x62x7 HMSA10 RG	40x62x7 HMSA10 RG	20
40x80x10 HMSA10 RG	40x80x10 HMSA10 RG	40x80x10 HMSA10 RG	20
45x62x7 HMSA10 V	45x62x7 HMSA10 V	45x62x7 HMSA10 V	20
45x62x10 HMSA10 RG	45x62x10 HMSA10 RG	45x62x10 HMSA10 RG	20
45x65x8 HMSA10 RG	45x65x8 HMSA10 RG	45x65x8 HMSA10 RG	20
45x65x8 HMS5 RG	45x65x8 HMS5 RG	45x65x8 HMS5 RG	20
45x72x8 HMSA10 RG	45x72x8 HMSA10 RG	45x72x8 HMSA10 RG	20
45x72x8 HMS5 RG	45x72x8 HMS5 RG	45x72x8 HMS5 RG	20
45x75x8 HMSA10 RG	45x75x8 HMSA10 RG	45x75x8 HMSA10 RG	20
46x68x8 CRW1 R	46x68x8 CRW1 R	46x68x8 CRW1 R	20
50x68x8 CRW1 R	50x68x8 CRW1 R	50x68x8 CRW1 R	20
50x72x8 HMSA10 RG	50x72x8 HMSA10 RG	50x72x8 HMSA10 RG	20
50x80x8 HMSA10 RG	50x80x8 HMSA10 RG	50x80x8 HMSA10 RG	20
50x80x10 HMSA10 RG	50x80x10 HMSA10 RG	50x80x10 HMSA10 RG	20
55x72x8 HMSA10 RG	55x72x8 HMSA10 RG	55x72x8 HMSA10 RG	20
55x80x8 HMSA10 RG	55x80x8 HMSA10 RG	55x80x8 HMSA10 RG	20
55x80x12,5/14 CASS T1	55x80 MUD11 R	55x80x13.5/14.5 MUD11	25
56x80x13/14,5 CASS T3	56x80 MUD11 R	56x80x13.5/14.5 MUD11	25
60x75x8 HMS5 RG	60x75x8 HMS5 RG	60x75x8 HMS5 RG	20
60x80x10 HMS5 RG	60x80x10 HMS5 RG	60x80x10 HMS5 RG	20
60x90x13,5/15 CASS T3	60x90 MUD11 R	60x90x14.5/15.5 MUD11	25
63x90x10 HMSA10 RG	63x90x10 HMSA10 RG	63x90x10 HMSA10 RG	20

Industry designation	SKF designation	Part Marking	Page
65x85x10 HMSA10 RG	65x85x10 HMSA10 RG	65x85x10 HMSA10 RG	20
65x90x13/14,5 CASS T3	65x90 MUD11 R	65x90x14.5/15.5 MUD11	25
65x95x14,5/15,5	65x95 MUD11 R	65x95x14.5/15.5 MUD11	25
65x100x10 HMSA10 RG	65x100x10 HMSA10 RG	65x100x10 HMSA10 RG	20
70x85x8 HMSA10 RG	70x85x8 HMSA10 RG	70x85x8 HMSA10 RG	20
70x90x10 HMSA10 RG	70x90x10 HMSA10 RG	70x90x10 HMSA10 RG	20
75x95x10 HMSA10 RG	75x95x10 HMSA10 RG	75x95x10 HMSA10 RG	20
70x95x13/14,5 CASS T3	70x95 MUD11 R	70x95x14.5/15.5 MUD11	25
70x100x14,5/15,5	70x100 MUD11 R	70x100x14.5/15.5 MUD11	25
75x100x10 HMS5 RG	75x100x10 HMS5 RG	75x100x10 HMS5 RG	20
75x105x13/14,5 CASS T3	75x105 MUD11 R	75x105x14.5/15.5 MUD11	25
80x110x14,5/15,5	80x110 MUD11 R	80x110x14.5/15.5 MUD11	25
85x115x12/12 CASS T2	85x115 MUD11 R	85x115x14.5/15.5 MUD11	25
90x120x14,5/15,5	90x120 MUD11 R	90x120x14.5/15.5 MUD11	25
100x130x14,5/15,5	100x130 MUD11 R	100x130x14.5/15.5 MUD11	25
110x140x13,5/15,5 CASS T3	110x140 MUD11 R	110x140x15/16 MUD11	25
130x160x14,5/16 CASS T3	130x160 MUD11 R	130x160x15/16 MUD11	25
140x170x14,5/16 CASS T3	140x170 MUD11 R	140x170x15/16 MUD11	25
145x175x14,5/15,5 CASS T3	145x175 MUD11 R	145x175x15/16 MUD11	25
150x180x14,5/16 CASS T3	150x180 MUD11 R	150x180x15/16 MUD11	25
165x190x15,5/17 CASS T3	165x190 MUD11 R	165x190x15/16 MUD11	25
170x200x15/16 CASS T3	170x200 MUD11 R	170x200x15/16 MUD11	25
4985	4985	4985	21
6904	6904	6904	21
6229	6229	6229	21
6373	6373	6373	21
7443	7443	7443	21
7512	7512	7512	21
7513	7513	7513	21
8624	8624	8624	21
8660	8660	8660	21
8648	8648	8648	21
8700	8700	8700	21
9837	9837	9837	21
9833	9833	9833	21
9843	9843	9843	21
9876	9876	9876	21
9878	9878	9878	21
9934	9934	9934	21
9935	9935	9935	21
9998	9998	9998	21
10114	10114	10114	21
10124	10124	10124	21
10681	10681	10681	21
10740	10740	10740	21
11067	11067	11067	21
11123	11123	11123	21
11124	11124	11124	21
11223	11223	11223	21
12350	12350	12350	21
12364	12364	12364	21
12363	12363	12363	21
12383	12383	12383	21
12427	12427	12427	21
12428	12428	12428	21
12456	12456	12456	21
12458	12458	12458	21
12577	12577	12577	21
12614	12614	12614	22
13534	13534	13534	22

Industry designation	SKF designation	Part Marking	Page
13535	13535	13535	22
13569	13569	13569	22
13651	13651	13651	22
13649	13649	13649	22
13865	13865	13865	22
14807	14807	14807	22
14832	14832	14832	22
14855	14855	14855	22
14939	14939	14939	22
14938	14938	14938	22
15005	15005	15005	22
15093	15093	15093	22
15142	15142	15142	22
15176	15176	15176	22
15517	15517	15517	22
15707	15707	15707	22
16062	16062	16062	22
16085	16085	16085	22
16128	16128	16128	22
16314	16314	16314	22
16364	16364	16364	22
16900	16900	16900	22
17231	17231	17231	22
17271	17271	17271	22
17285	17285	17285	22
17387	17387	17387	22
17386	17386	17386	22
17404	17404	17404	22
17443	17443	17443	22
17607	17607	17607	22
17523	17523	17523	22
17557	17557	17557	22
17653	17653	17653	22
18565	18565	18565	22
18562	18562	18562	23
18581	18581	18581	23
18671	18671	18671	23
19227	19227	19227	23
19229	19229	19229	23
19359	19359	19359	23
19360	19360	19360	23
19380	19380	19380	23
19745	19745	19745	23
19762	19762	19762	23
19786	19786	19786	23
19832	19832	19832	23
19876	19876	19876	23
19969	19969	19969	23
19979	19979	19979	23
21352	21352	21352	23
22354	22354	22354	23
22400	22400	22400	23
22493	22493	22493	23
22532	22532	22532	23
22558	22558	22558	23
23061	23061	23061	23
23184	23184	23184	23
24898	24898	24898	23
24899	24899	24899	23
24988	24988	24988	23

Industry designation	SKF designation	Part Marking	Page
25091	25091	25091	23
25102	25102	25102	23
27269	27269	27269	23
27362	27362	27362	23
27368	27368	27368	23
27370	27370	27370	23
27565	27565	27565	23
27625	27625	27625	23
28790	28790	28790	23
29224	29224	29224	23
29906	29906	29906	24
29907	29907	29907	24
30087	30087	30087	24
30095	30095	30095	24
33701	33701	33701	24
33772	33772	33772	24
43771	43771	43771	24
52488	52488	52488	24
Conversion Tables Bearings and units – 15123/15245 to 205PPB7			
15123/15245	15123/15245	Cone: 15123 / Cup: 15245	17
15123/15250	PER.15123 and PER.15250	Cone: 15123/ Cup: 15250	61
15126/15250	PER.15126 and PER.15250	Cone: 15126/ Cup: 15250	61
16150/16284	16150/16284/Q	Cone: 16150 / Cup: 16284	17
18590/18520	18590/18520/Q	Cone: 18590 / Cup: 18520	17
18690/18620	18690/18620/Q	Cone: 18690 / Cup: 18620	17
202KRR3	PER.202HRR3	203KRR3	50
202NPP9	PER.CF202RRR9	202NPP9	55
203JD	PER.203RRY61	203RRY61	44
203KPP50	PER.203RPP50	203KPP50	48
203KRR2	PER.203RRR2	203KRR2	48
203KRR2FD	PER.203RYY2	203KRR2FD	43
203KRR2R	PER.203RRR2-G	203KRR2	48
203KRR3	PER.CF203RRR3-B	203KRR3	58
203KRR5	PER.203RRR5-A	203KRR5	50
203KRR50	PER.203RRR2-B	203KRR50-SP1	48
203KRR6	PER.203RRR6	203KRR6	50
203NPP9	PER.203RRR9	203NPP9	42, 44
204KRD4	PER.204RRR4	204RRR4	42
204KRR2	PER.204HRR2	204KRR2	48
	PER.204HRR2-B	204KRR2	48
204KRR2-NR	PER.204HRR2-C	204HRR2-C	45
204KRR2-ZZ	PER.204HZZ2	204HZZ2	45
204KYY2-H-A256	PER.204HYY2	204HYY2	45
204PY3	PER.BB204RRY3-A	204PY3	42
205KP8	PER.205RP8	205RP8	43
205KPP2	PER.205HPP2	205KPP2	45
205KPP54	PER.205HPPB54	205KPPB54	45
205KPPB2	PER.205HPPB2	205KPPB2	50
205KR3	PER.205RY3	205KR3	57
205KR3-SP1	PER.205RR3	205RR3	45
205KRP2	PER.205RRP2	205KRP2	43
205KRP5	PER.205RRP5	205KRP5	43
205KRR2	PER.205HRR2	205HRR2	45
205KRRB2	PER.205HRRB2	205KRRB2	45
205KYY3	PER.205RYY3	205KYY3	58
205PP10	PER.205RPP10	205PP10	50
205PP13	PER.BB205RPP13	BB205RPP13	43
205PP9	PER.205RPP9	205PP9	50
205PPB7	PER.205RPPB7	205PPB7-SP1	50

Industry designation	SKF designation	Part Marking	Page
206KP2	PER.206RP2	206KP2	50
206KPP16	PER.206RPP16	206KPP16	57
206KPP3	PER.206HPP3	206HPP3	45
206KPPB5	PER.206HPPB5	206KPPB5	50
206KRP4	PER.206RRP4	206KRP4	43
206KRP50	PER.206RRP50	206-KRP50	43
206KRR14	PER.206RRR14	206KRR14	57
206KRR6	PER.206HRR6	206KRR6	50
206KRRB6	PER.206HRRB6	206KRRB6	48
207KPPB55	PER.207HPPB55	207KPPB55	57
207KPPB57-FT	PER.207HPPB57-FT	207KPPB57 FT207	48
207KRR14	PER.207RRR14	207KRR14	50
207KRR3	PER.207RRR3	207KRR3	51
207KRRB12	PER.207HRRB12	207KRRB12	55
207KRRB17	PER.207HRRB17	207KRRB17	55
207KRRB58-H	PER.207HRRB58	207KRRB58	50
207KRRB9	PER.207HRRB9	207KRRB9	48
207XTR-R-DFC-A305	PER.207RRSB-FC-A	207XTR	35
208KPPB52	PER.208HPPB52	208KPPB52	50
208KRR4	PER.208RRR4	208KRR4	57
208NPPB5	PER.208RRRB5	208NPPB5	58
209KRRB2	PER.209HRRB2	209KRRB2	49
210PP20	PER.210HPP20	210PP20	57
210PPB20	PER.210HPPB20	210PPB20	49
2790/2720	PER.2790/20	Cone: 2790 / Cup: 2790	61
22208 E	22208 E	22208 E	49
22211 E	22211 E	22211 E	52
22213 E	22213 E	22213 E	58
22213 E/C3	22213 E/C3	22213 E/C3	52
23220 CC/W33	23220 CC/W33	23220 CC/W33	58
24780/24720	24780/24720/Q	Cone: 24780 / Cup: 24720	17
25572/25520	25572/25520/Q	Cone: 25572 / Cup: 25520	17
25580/25520	PER.25580/20	Cone: 25580 / Cup: 25520	61
25590/25520	PER.25590/20	Cone: 25590 / Cup: 25520	61
25877/25821	PER.25877 and PER.25821	Cone: 25877 / Cup: 25821	61
2BF205-7/8HX	PER.205HPPB2-2BF	2BF205-7/8HX	45
342A-d2/332	PER.342A-A and PER.332	Cone: 342A / Cup: 332	61
387AS/382A	PER.387AS and PER.382A	Cone: 387AS / Cup: 382A	61
3201 ATN9	3201 ATN9	3201 ATN9	48
3202 CETN9	3202 CETN9	3202 CETN9	31
3204 CE-2RS1TN9/C3	3204 CE-2RS1TN9/C3	3204 CE-2RS1TN9/C3	48
3204 CE-2RSH1TN9	3204 CE-2RSH1TN9	3204 CE-2RSH1TN9	42
3204 CETN9	3204 CETN9	3204 CETN9	42
3206 CE-2RSH1TN9	3206 CE-2RSH1TN9	3206 CE-2RSH1TN9	31
3207 CE-2RSH1TN9	3207 CE-2RSH1TN9	3207 CE-2RSH1TN9	31
3207 CETN9	3207 CETN9	3207 CETN9	31
3214 A	3214 A	3214 A	48
3304 CE-2RSH1TN9	3304 CE-2RSH1TN9	3304 CE-2RSH1TN9	42
3304 CETN9	3304 CETN9	3304 CETN9	42
3306 CE-2RSH1TN9	3306 CE-2RSH1TN9	3306 CE-2RSH1TN9	31
3306 CETN9	3306 CETN9	3306 CETN9	31
3307 CE-2RSH1TN9	3307 CE-2RSH1TN9	3307 CE-2RSH1TN9	31
3307 CETN9	3307 CETN9	3307 CETN9	31
3780/3720	PER.3780/20	Cone: 3780 / Cup: 3720	61
30205	30205 J2/Q	30205	13
30206	30206	30206	13
30207	30207 J2/Q	30207	13
	PER.30207	Cone: X30207 / Cup: Y30207	61

Industry designation	SKF designation	Part Marking	Page
30208	30208	30208	13
30209	30209	30209	13
30210	30210	30210	14
30211	30211	30211	14
30212	30212	30212	14
30213	30213	30213	14
30214	30214 J2/Q	30214	15
30215	30215	30215	15
30216	30216	30216	15
30217	30217	30217	15
30218	30218	30218	16
30219	30219	30219	16
30220	30220	30220	16
30220/DF	30220/DF	30220/DF	18
302/28	302/28 J2	302/28	13
30305	30305	30305	13
30306	30306	30306	13
30307	30307	30307	13
30308	30308	30308	13
30309	30309	30309	14
30310	30310	30310	14
30311	30311	30311	14
30312	30312 J2/Q	30312	14
30313	30313	30313	15
30314	30314	30314	15
30315	30315	30315	15
30316	30316	30316	15
30317	30317 J2	30317	15
30318	30318	30318	16
30320	30320	30320	16
31305	31305	31305	13
31306	31306	31306	13
31307	31307	31307	13
31311	31311	31311	14
31312	31312	31312	14
31317	31317	31317	16
31318	31318	31318	16
31318/DF	31318/DF	31318/DF	18
31318/DFC70	31318/DFC70	31318/DFC70	18
31319	31319	31319	16
31319/DF	31319/DF	31319/DF	18
31319/DFC190	31319/DFC190	31319/DFC190	18
31320 X	31320 X	31320 X	16
31320 X/DF	31320 X/DF	31320 X/DF	18
320/28 X	320/28 X	320/28 X	13
320/32 X	320/32 X	320/32 X	13
32005 X	32005 X/Q	32005 X	13
32006 X	32006 X	32006 X	13
32007 X	32007 X	32007 X	13
32008 X	32008 X	32008 X	13
32009 X/Q	32009 X	32009 X	13
32010 X	32010 X	32010 X	14
32011 X	32011 X	32011 X	14
32013 X	32013 X	32013 X	14
32014 X	32014 X	32014 X	15
32015 X	32015 X	32015 X	15
32016 X	32016 X	32016 X	15
32017 X	32017 X	32017 X	15
32018 X	32018 X	32018 X	16
32019 X	32019 X	32019 X	16

Conversion Tables | Bearings and units – 322/28 B to 33118

Industry designation	SKF designation	Part Marking	Page
322/28 B	322/28 B	322/28 B	13
32205 B	32205 BJ2/Q	32205 B	13
32206	32206	32206	13
32207	32207	32207	13
32208	32208	32208	13
32209	32209	32209	14
32210	32210	32210	14
32211	32211	32211	14
32212	32212	32212	14
32213	32213	32213	15
32214	32214 J2/Q	32214	15
32215	32215	32215	15
32216	32216	32216	15
32217	32217	32217	15
32218	32218	32218	16
32219	32219	32219	16
32219/DF	32219/DF	32219/DF	18
32220	32220	32220	16
32220/DF	32220/DF	32220/DF	18
32305	32305	32305	13
32306	32306	32306	13
32307	32307 J2/Q	32307	13
32307 B	32307 B	32307 B	13
32308	32308	32308	13
32309	32309	32309	14
32310	32310	32310	14
32311	32311	32311	14
32312	32312	32312	14
32313	32313	32313	15
32314	32314	32314	15
32315	32315	32315	15
32316	32316 J2	32316	15
32317	32317 J2	32317	16
32318	32318	32318	16
32319	32319	32319	16
32320	32320	32320	16
32911	32911/Q	32911	14
32920	32920	32920	16
33010	33010/Q	33010	14
33011	33011	33011	14
33012	33012	33012	14
33013	33013	33013	14
33014	33014	33014	15
33015	33015	33015	15
33016	33016	33016	15
33017	33017	33017	15
33018	33018	33018	16
33019	33019	33019	16
33020	33020	33020	16
33108	33108	33108	13
33109	33109	33109	13
	PER.33109	Cone: X33109 / Cup: Y33109	61
33110	33110	33110	14
33111	33111/Q	33111	14
33112	33112	33112	14
33114	33114	33114	15
33115	33115	33115	15
33116	33116	33116	15
33117	33117	33117	15
33118	33118	33118	16

Industry designation	SKF designation	Part Marking	Page
33205	33205	33205	13
33206	33206	33206	13
33207	33207	33207	13
33208	33208	33208	13
33209	33209	33209	14
33210	33210	33210	14
33211	33211	33211	14
33212	33212	33212	14
33213	33213	33213	15
33214	33214	33214	15
33215	33215	33215	15
33216	33216	33216	15
33217	33217	33217	15
33889/33821	PER.33889 and PER.33821	Cone: 33889 / Cup: 33821	61
37431A/37625	PER.37431A/37625	Cone: 37431A / Cup: 37625	25
39581/39520	39581/39520/Q	Cone: 39581 / Cup: 39520	17
39585/39520	PER.39585 and PER.39520	Cone: 39585 / Cup: 39520	61
460/453A	PER.460 and PER.453A	Cone: 460 / Cup: 453A	61
462/453X	462/453 X/VB535	Cone: 462 / Cup: 453X	17
4580/4535	4580/2/4535/2/Q	Cone: 4580 / Cup: 4535	17
42687/42620	42687/42620	Cone: 42687 / Cup: 42620	17
42690/42620	42690/42620/Q	Cone: 42690 / Cup: 42620	17
45289/45220	PER.45289 and PER.45220	Cone: 45289 / Cup: 45220	61
47487/47420A	47487/47420 A/Q	Cone: 47487 / Cup: 47420A	17
535/532A	535/532 A	Cone: 535 / Cup: 532A	17
537/532X	537/532 X/Q	Cone: 537 / Cup: 532X	17
539/532X	539/532 X	Cone: 539 / Cup: 532X	17
5203-KMF57-R-ZDFC-A576	PER.5203RSS57-FC	5203RSS57-FC	40
5203-KMF-R-A120	PER.5203RSS2-A	5203KMF SEEDXTREME	44
5203-KMF-R-A230	PER.5203RSS2	5203RSS2	44
5203-KPP2	PER.5203RPP2-A	5203KPP2	43
5203-KPP52-R-A100	PER.5203RPP52	5203RPP52	44
5203-KPP52-R-A121	PER.5203RPP52-A	5203RPP52-A	44
5203-KPP54-R-A552	PER.5203RPP54	5203RPP54	44
5203-KRMF-R-A517	PER.W5203RRF58	W5203RRF58	44
5203-KRR2-R-A230	PER.5203RRR2	5203KRR2	44
5203-KYY2	PER.5203RYY2	5203KYY2	44
5203-KYY50-ASSY	PER.5203NYY50	5203KYY50	45
5203-ZZ	PER.5203-ZZW	5203Z	44
5204-2RS	PER.5204-2RSW	5204RS	42
5204-KP52-R-A116	PER.5204RP52-A	5204KP52-SP	43
5204-KP52-SP6	PER.W5204RP52-D	5204KP52-SP	43
5204-KPP53	PER.5204RPP53	5204RPP53	44
5204-KPP55	PER.5204RPP55	5204KPP55	43
5204-KRMF	PER.5204RRF57-A	5204KRMF	42
5204-KRP50	PER.5204RRP50	5204RRP50	43
5204-KRP51	PER.5204RRP51	5204KRP51	43
5204-KRP52	PER.5204RRP52	5204KRP52	43
5204-KRY2	PER.5204RRY2	5204RRY2	42
5206-KFP50	PER.5206RRP50	5206RRP50	44
5206-KPP3	PER.5206RPP3	5206KPP3	43
5208-KMF50	PER.5208RSS50	5208RSS50	44
53178/53377	53178/53377	Cone: 53178 / Cup: 53377	17
6012-2RS1	6012-2RS1	6012-2RS1	52
6015-2RS1	6015-2RS1	6015-2RS1	48
6020-2RS1	6020-2RS1	6020-2RS1	52
6207-2RS1	6207-2RS1	6207-2RS1	54
6207-2RSH	6207-2RSH	6207-2RSH	54
6211-2RS1/C3	6211-2RS1/C3	6211-2RS1/C3	57

Industry designation	SKF designation	Part Marking	Page
6218-2RS1	6218-2RS1	6218-2RS1	52
6304-2RSH	6304-2RSH	6304-2RSH	48
6307-2RS1	6307-2RS1	6307-2RS1	54, 57
6307-2RSH	6307-2RSH	6307-2RSH	54
6901PK	PER.CF6901NY-A	6901PK	58
6901PKVW2	PER.CF6901NY	6901PK-A539	58
AGHU1675X6H-1LLC	AGHU1675X6H-1LLC	AGHU1675X6H-1LLC	40
AGHU1675X6H-1LMB	AGHU1675X6H-1LMB	AGHU1675X6H-1LMB	40
AGHU1675X6H-LC1L	AGHU1675X6H-LC1L	AGHU1675X6H-LC1L	40
AGHU1675X6H-MB1L	AGHU1675X6H-MB1L	AGHU1675X6H-MB1L	40
AGHU2075X6F-1LLC	AGHU2075X6F-1LLC	AGHU2075X6F-1LLC	41
AGHU2075X6F-1LMB1	AGHU2075X6F-1LMB1	AGHU2075X6F-1LMB1	41
AGHU2075X6H-1LLC	AGHU2075X6H-1LLC	AGHU2075X6H-1LLC	41
AGHU2075X6H-LC1L	AGHU2075X6H-LC1L	AGHU2075X6H-LC1L	41
AGHU2075X6H-MB1L	AGHU2075X6H-MB1L1	AGU2075X6H-MB1L 123S	41
AGHU2080X6F-1LMB	AGHU2080X6F-1LMB	AGHU2080X6F-1LMB	41
AGHU2898X4E-DSCS	AGHU2898X4E-DSCS	AGHU2898X4E-DSCS	29
AGHU2898X5E-DSCS	AGHU2898X5E-DSCS	AGHU2898X5E-DSCS	29
AGHU2898X6E-DSCS	AGHU2898X6E-DSCS	AGHU2898X6E-DSCS	29
AGHU3098X4C-6L1L	PER.HUB30-001	AGHU3098X4C-6L1L	29
AGPU40236X4N01-MC	BX-AGPU40236X4N01-MC	AGPU40236X4N01-MC	28
BAA 0003	BAA 0003	BAA 0003	29
BAA 0003 A	BAA 0003 A	BAA 0003 A	29
BAA-0004	BAA-0004	BAA-0004	29
BAA 0005	BAA 0005	BAA 0005	29
BAA-0006	BAA-0006	BAA-0006	29
BAA-0012	BAA-0012	BAA-0012	29
BAA-0013	BAA-0013	BAA-0013	29
BAA-0023	BAA-0023	BAA-0023	29
BAA-0037	BAA-0037	BAA-0037	30
BAA-0044	BAA-0044	BAA-0044	29
BAA-0045	BAA-0045	BAA-0045	30
BAA-0047	BAA-0047	BAA-0047	29
BAA-0048	BAA-0048	BAA-0048	29
BAH-0013 AB	BAH-0013 AB	BAH-0013 AB	54
BAH-0013 D	BAH-0013 D	BAH-0013 D	54
BAH-0013 E	BAH-0013 E	BAH-0013 E	54
BAH-0069	BAH-0069	BAH-0069	55
BAHB 636187 C	BAHB 636187 C	BAHB 636187 C	31
BB203-KRR2	PER.BB203RRR2	BB203RRR2	44
BB203-KRR5	PER.BB203RRR5	BB203KRR5	42, 44
BB203-KYY2	PER.BB203RYY2-B	BB203KYY2	43, 44
BB203-KYY2-R-A138	PER.BB203RYY2	BB203RYY2	44
BB203-KYY50	PER.BB203RYY50	BB203RYY50	44
BB204-KPMF59	PER.BB204RPS59-FC	FC204 BB204KPMF59	41
BB204-KYY2-H	PER.BB204HYY2	BB204KYY2	48
BB204-PF3-R-A453	PER.BB204RRP3	BB204PF3	42
BB204-PY3-R-A513	PER.BB204RRY3-D	BB204RRY3-D	42
BB204-PY3-R-ZDFC-A481	PER.BB204RRY3-FC-A	BB204RRY3-FC-A	40
BB205-KRP2	PER.BB205RRP2	BB205KRP2	43
BB205-KRP2-16.03M-E	PER.BB205RRP2-A	BB205RRP2-A	42
BB304-PP50	PER.BB304RPP50	BB304PP50	43
BBY-0076	BBY-0076	BBY-0076	58
BBY-0083	BBY-0083	BBY-0083	58
BS2-2206-2RS/VT143	BS2-2206-2RS/VT143	BS2-2206-2RS/VT143	49
BS2-2207-RS/VT143	BS2-2207-RS/VT143	BS2-2207-RS/VT143	49
BS2-2208-2RS/VT143	BS2-2208-2RS/VT143	BS2-2208-2RS/VT143	49
BS2-2208-2RSW/GEM9	BS2-2208-2RSW/GEM9	BS2-2208-2RSW/GEM9	49
BS2-2210-2RS/VT143	BS2-2210-2RS/VT143	BS2-2210-2RS/VT143	52
BS2-2212-2RS/VT143	BS2-2212-2RS/VT143	BS2-2212-2RS/VT143	49
BTH-1024 AE	BTH-1024 AE	BTH-1024 AE	31
BTHB1866046ACQ	BTHB1866046ACQ	BTHB1866046ACQ	58

Industry designation	SKF designation	Part Marking	Page
CF5002-ASSY	PER.CF5002NYY8	CF5002-ASSY	55
CF5202-2RST-8	PER.CF5202RYY	CF5202-RST-8	55
CF6007PP51-SP1	PER.CF6007RPP51	CF6007-PP51-SP1	57
FD209-1-1/2RD	PER.FD209RVVB52 PER.FD209RSSB53	FD209K52 209K53	37 37
FD209-1-1/4RD FD209-1-1/4SQ	PER.FD209RVVB54 PER.FD209SVVB51 PER.GFD209SPPB51	FD209K54 FD209K51 FD209-1-1/4SQ	37 37 37
FD209-1-1/8SQ	PER.FD209SVVB57 PER.GFD209SPPB57	FD209K57-1-1/8SQ TILLXTREME FD209-1-1/8SQ	37 37
FD211-1-1/2SQ	PER.FD211SVVB53 PER.GFD211SPPB53	TILLXTREME FD211K53-1-1/2SQ FD211-1-1/2SQ	37 37
FD211-1-15/16RDC	PER.FD211RVVB65 PER.GFD211RPPB65	FD211K65-1-15/16RDC TILLXTREME FD211-1-15/16RDC	37 37
FD211-1-3/4RD	PER.GFD211RPPB51-A PER.GFD211RPPB51 PER.FD211RVVB51-A PER.FD211RVVB51	FD211-1-3/4RD FD211-1-3/4RD FD211K52-1-3/4RD TILLXTREME FD211K51-1-3/4RD TILLXTREME	35, 37 35 37 37
FD211-2-3/16RD	PER.FD211RVVB61 PER.GFD211RPPB61	TILLXTREME FD211K61 FD211-2-3/16RD	37 37
FD212K51-60RD	PER.FD212RVVB51	FD211K51-60RD	37
FH205-14-AP	PER.FH205-14A	FH205-14-AP	50
FH205-16-AP	PER.FH205-16A	206F PEER FH205-16-AP	50
FH205-25MM-AP	PER.FH205A	205F PEER FH205-25MM-AP	50
FH206-18-AP	PER.FH206-18A	FH206-18-AP	48, 50
FH206-19-AP	PER.FH206-19A	FH206-19-AP	50
FH206-20-AP	PER.FH206-20A	FH206-20-AP	50
FH206-30MM-AP	PER.FH206A	206F PEER FH206-30MM-AP	50
FH207-20-AP	PER.FH207-20A	FH207-20	50
FH207-22-AP	PER.FH207-22A	FH207-22-AP	51
FH207-23-AP	PER.FH207-23A	207F FH207-23-AP	51
FH207-35mm-AP	PER.FH207A-B	FH207-35MM-AP	51
FH208-24-AP	PER.FH208-24AF-A	FH208-24-AP	51
FH208-40MM-AP	PER.FH208-40MMA	FH208-40MM-AP	49, 51
FH209-28-AP	PER.FH209-28A	209F FH209-28-AP	51
FH209-45MM-AP	PER.FH209A	209F FH209-45MM-AP	51
FHR207-22-AP-SP2	PER.FHR207-22A	FHR207-22	51
FHR208-24-AP	PER.FHR208-24A	FHR208-24-AP 208F	57
FHRL6005-BB9105	PER.FHR6005-XD-A	FHRL6005-BB9105	55
FHRL6005-BB9105-EE-SP1	PER.FHR6005-XD-D	FHRL6005-BB9105-EE-SP1	55
FY 2.7/16 TF	FY 2.7/16 TF	FY 2.7/16 TF	53
FY 35 TF	FY 35 TF	FY 35 TF	36
FY 40 TF	FY 40 TF	FY 40 TF	36
FY 45 TF	FY 45 TF	FY 45 TF	36
FY 50 TF	FY 50 TF	FY 50 TF	36
FY 50 TR	FY 50 TR	FY 50 TR	36
FY 60 TF	FY 60 TF	FY 60 TF	36
FYC 40 TF	FYC 40 TF	FYC 40 TF	36
FYC 50 TF	FYC 50 TF	FYC 50 TF	36
FYTBK 20 WD	FYTBK 20 WD	FYTBK 20 WD	53
FYTBK 25 WD	FYTBK 25 WD	FYTBK 25 WD	53
FYTBK 30 WD	FYTBK 30 WD	FYTBK 30 WD	53
G206KPPB4	PER.G206HPPB4	G206KPPB4	50
G207KRR28-HX	PER.G207HRR28	G207KRR28	50
GRFT206-30MM-DBL	PER.GRNFT206A-A	FT206	35
GW208KPPB50	PER.GW208HPPB50	GW208-KPPB50	57
GW208KPPB50-H-OX-DF4X	PER.GW208HPPB50-F4X	GW208KPPB50	56
GW208PP17	PER.GW208SPP17	GW208PP17	32
GW208PP5	PER.GW208SPP5	GW208PP5	32

Industry designation	SKF designation	Part Marking	Page
GW208PPB22	PER.GW208HPPB22	GW208PPB22	57
GW208PPB29	PER.GW208HPPB29	GW208PPB29	57
GW208PPB5	PER.GW208SPPB5	GW208PPB5	32
GW208PPB6	PER.GW208SPPB6	GW208PPB6	32
GW208PPB8	PER.GW208SPPB8	GW208PPB8	32
GW209PP8	PER.GW209SPP8	GW209PP8	32
GW209PPB11	PER.GW209RPPB11	GW209RPPB11-B	32
GW209PPB2	PER.GW209RPPB2	GW209PPB2	32
GW209PPB22-BR209RH	PER.GW209RPPB22-BR	GW209PPB22	34
GW209PPB23-BR209RH	PER.GW209RPPB23-BR	GW209PPB23	34
GW209PPB4	PER.GW209RPPB4	GW209PPB4	32
GW209PPB5	PER.GW209SPPB5	GW209PPB5	32
GW210KPPB50-F4X	PER.GW210HPPB50-F4X	210T GW210KPPB50	56
GW210KPPB50	PER.GW210HPPB50	GW210KPPB50	57
GW210PP54	PER.GW210RPP54	GW210PP54	32
GW210PPB4	PER.GW210SPPB4	GW210PPB4-GX	32
GW211KPPB51-FS	PER.GW211HPPB51-FS	GW211KPPB51	56
GW211KPPB51-OX	PER.GW211HPPB51	GW211KPPB51	57
GW211PP17	PER.GW211SPP17	GW211PP17	32
GW211PP17-HDT-211-H	PER.GW211SPP17-TTU	GW211PP17	34
GW211PP2	PER.GW211RPP2	GW211PP2	32
GW211PP25-HDT	PER.GW211RPP25-TTU	GW211PP25	34
GW211PP3	PER.GW211SPP3	GW211PP3	32
GW211PP32	PER.GW211RPP32	GW211PP32	32
GW211PP37	PER.GW211RPP25	GW211PP25	32
GW211PP53	PER.GW211RPP53	GW211PP53	32
GW211PPB13	PER.GW211RPPB13	GW211PPB13	32
GW211PPB14	PER.GW211RPPB14	GW211PPB14	32
GW211PPB2	PER.GW211RPPB2	GW211PPB2	32
GW211PPB21	PER.GW211RPPB21-BR	GW211PPB21	34
GW211PPB3	PER.GW211SPPB3	GW211PPB3	32
GW211PPB8	PER.GW211RPPB8	GW211PPB8	32
GW211PPB9	PER.GW211RPPB9	GW211PPB9	32
GW212PP50	PER.GW212SPP50	GW212PP50	32
GW214PP2	PER.GW214RPP2	GW214PP2	32
GW214PP3	PER.GW214RPP3	GW214PP3	32
GW214PPB2	PER.GW214RPPB2	GW214PPB2	32
GW214PPB3	PER.GW214RPPB3	GW214PPB3	32
GW214PPB4	PER.GW214SPPB4	GW214PPB4	32
GW214PPB6	PER.GW214RPPB6	GW214PPB6	32
GW216PP2	PER.GW216SPP2	GW216PP2	32
GW315PPB11	PER.GW315RPPB11	GW315PPB11	32
GW5209KYYB2	PER.GW5209HYYB2	GW5209HYYB2	48
HC205-16-AP	PER.HC205-16A-A	HC205-16-AP	50
HC205-25MM-AP	PER.HCN205A	205G PEER HC205-25MM-AP	50
HC206-30MM-AP	PER.HC206A	206T PEER HC206-30MM-AP	50
HC207-20-AP	PER.HCN207-20A-A	HC207-20-AP	50
HC207-22-AP	PER.HC207-22A-B	HC207-22-AP	51
HC207-23-AP	PER.HC207-23A-A	HC207-23-AP	51
HC207-35MM-AP	PER.HCN207A	HC207-35MM-AP	51
HC208-24-AP	PER.HCN208-24A-A	HC208-24-AP	51
HC208-40MM-AP	PER.HCN208A	HC208-40MM-AP	51
HC209-26-AP	PER.HC209-26A	HC209-26-AP	51
HC209-28-AP	PER.HC209-28A	HC209-28-AP	51
HC209-45MM-AP	PER.HCN209-A	209G HC209-45-AP	51
HCF3X206-30MM-AP	PER.HCF3X206ATN-A	206T HC206-30MM-AP	56
HCFS310-50MM-AP	PER.HCFS310A-A	310 HC310-50MM-AP	56
HM212049 / HM212011	PER.HM212049/11	Cone: HM212049 / Cup: HM212011	61
HM218248 / HM218210	PER.HM218248 and PER.HM218210	Cone: HM218248 / Cup: HM218210	61
HM220149 / HM220110	HM 220149/110	Cone: HM220149 / Cup: HM220110	17
HM801346 / HM801310	HM 801346/310	Cone: HM801346 / Cup: HM801310	17
HM803149 / HM803110	PER.HM803149/10	Cone: HM803149 / Cup: HM803110	61

Industry designation	SKF designation	Part Marking	Page
HUB-16MM-X	PER.HUB16-001	SEEDXTREME HUB-16MM-X	40
HUB-16MM-X-R-A391	PER.HUB16-005	HUB16-005	40
HUB-20MM-ASSY-A671	PER.HUB20-009	5304KMF4 SEEDXTREME	41
HUB-20MM-X	PER.HUB20-001	HUB20-001	41
HUB-20MM-X-ASSY-A546	PER.HUB20-002	HUB-20MM-X	41
HUB-20MM-X-ASSY-A553	PER.HUB20-003	HUB-20MM-X-ASSY-A553	41
HUB-20MM-X-ASSY-A605	PER.HUB20-004	TILLXTREME HUB-20MM-X-ASSY-A605	41
HUB-20MM-X-ASSY-A613	PER.HUB20-005	TILLXTREME HUB-20MM-X-ASSY-A613	41
HUB-30MM-ASSY-A528	PER.HUB30-020	SEEDXTREME 5206	41
HUB-30MM-X-ASSY-A549	PER.HUB30-007	HUB-30MM-X-ASSY-A549 SEEDXTREME	41
HUB-30MM-X-ASSY-A603	PER.HUB30-011	TILLXTREME HUB-30MM-X-ASSY-A603	29
HUB-30MM-X-ASSY-A615	PER.HUB30-022	TILLXTREME HUB-30MM-X	29
HUB-30MM-X-ASSY-A626	PER.HUB30-010	TILLXTREME HUB-30MM-X-ASSY-A626	29
HUB-35MM-ASSY-A519	PER.HUB35-005	TILLXTREME HUB-35MM	30
HUB-35MM-X-ASSY-A601	PER.HUB35-006	HUB-35MM-X-A601 TILLXTREME	30
HUB-40MM-ASSY	PER.HUB40-001	HUB-40MM TILLXTREME	30
HUB-40MM-X-ASSY-A436	PER.HUB40-004	TILLXTREME HUB-40MM-X-ASSY	30
HUB-40MM-X-ASSY-A438	PER.HUB40-002	TILLXTREME HUB-40MM-X-ASSY-A438	30
HUB-40MM-X-ASSY-A591	PER.HUB40-007	TILLXTREME HUB-40MM-X-ASSY	30
HUB-40MM-X-ASSY-A614	PER.HUB40-008	HUB-40MM-X-ASSY-A614 TILLXTREME	30
HUB-40MM-X-ASSY-A628	PER.HUB40-009	TILLXTREME HUB-40MM-X-ASSY-A628	30
JL69349 / JL69310	PER.JL69349/10	Cone: JL69349 / Cup: JL69310	61
JL819349 / JL819310	PER.JL819349/10	Cone: JL819349 / Cup: JL819310	25
JLM104948 / JLM104910	PER.JLM104948 and PER.JLM104910	Cone: JLM104948 / Cup: JLM104910	61
JLM506849 / JLM506810	PER.JLM506849/10	Cone: JLM506849 / Cup: JLM506810	61
KIT-HUB-16MM-X-R-A70	PER.KITHUB16-001	KIT-HUB-16MM-X-R-A70	40
KIT-HUB-20MM-X-ASSY-A157	PER.KITHUB20-001	AGHU2080X5C-6LC	41
KIT-HUB-30MM-ASSY-A74	PER.KITHUB30-001	HUB-30MM-ASSY-A74	29
KIT-HUB-30MM-X-ASSY-A221	PER.KITHUB30-003	HUB-30MM-X-ASSY-A221	29
KIT-HUB-30MM-X-ASSY-A249	PER.KITHUB30-004	HUB-30MM-X-ASSY-A249	29
KIT-HUB-35MM-ASSY-A74	PER.KITHUB35-001	HUB-35MM-ASSY-A74	30
KIT-HUB-35MM-X-ASSY-A243	PER.KITHUB35-002	HUB-35MM-X-ASSY-A243	30
KIT-HUB-40MM-ASSY-A74	PER.KITHUB40-001	HUB-40MM-ASSY-A74	30
L44643 / L44610	L 44643/610/VU990	Cone: L44643 / Cup: L44610	17
L44649 / L44610	L 44649/610/Q	Cone: L44649 / Cup: L44610	17
	PER.L44649/10	Cone: L44649 / Cup: L44610	61
L45449 / L45410	L 45449/410/Q	Cone: L45449 / Cup: L45410	17
L68149 / L68110	L 68149/110/Q	Cone: L68149 / Cup: L68110	17
L68149 / L68111	L 68149/111/Q	Cone: L68149 / Cup: L68111	17
	PER.68149/11	Cone: L68149 / Cup: L68111	61
LM11949 / LM11910	PER.LM11949/10	Cone: LM11949 / Cup: LM11910	61
LM29749 / LM29710	PER.LM29749/10	Cone: LM29749 / Cup: L29710	61
LM29748 / LM29710	LM 29748/710/VU990	Cone: LM29748 / Cup: LM29710	17
LM29749 / LM29710	LM 29749/710/Q	Cone: LM29749 / Cup: LM29710	17
LM44643 / L44610	PER.L44643/10	Cone: L44643 / Cup: L44610	61
LM48548 / LM48510	PER.LM48548/10	Cone: LM48548 / Cup: LM48510	61
LM48548A / LM48510	LM 48548 A/510	Cone: LM48548A / Cup: LM48510	17
LM67048 / LM67010	PER.LM67048/10"	Cone: LM67048 / Cup: LM67010	61
LM102949 / LM102910	LM 102949/910/Q	Cone: LM102949 / Cup: LM102910	17
	PER.LM102949/10	Cone: LM102949 / Cup: LM102910	61
LM104949 / LM104911	PER.LM104949/11	Cone: LM104949 / Cup: LM104911	61
LM127949 / LM12710	PER.LM12749/10	Cone: LM12749 / Cup: LM12710	61
LM300849 / LM300811	LM 300849/811/Q	Cone: LM300849 / Cup: LM300811	17
LM501349 / LM501310	LM 501349/310/Q	Cone: LM501349 / Cup: LM501310	17
	PER.LM501349/10	Cone: LM501349 / Cup: LM501310	61
LM501349 / LM501314	LM 501349/314/Q	Cone: LM501349 / Cup: LM501314	17
LM503349 / LM503310	LM 503349/310/QCL7C	Cone: LM503349 / Cup: LM503310	17
LM603049 / LM603011	PER.LM603049/11	Cone: LM603049 / Cup: LM603011	61
N205-KPPB2-H	PER.205HPPB2-A	205HPPB2-A	45
RFD205K50-1-1/8SQ	PER.RFD209SVVB50	RFD209K50-1-1/8SQ	36

Industry designation	SKF designation	Part Marking	Page
ST491A	PER.FD209RVVB50	FD209K50	37
	PER.FD209RVVB58	TILLXTREME FD209K58-1-3/4RD	37
	PER.GFD209RPPB58	ST491A	37
ST491A-B-SP1 ST491B	PER.GFD209RPPB50 PER.GFD209RPPB52	ST491A-B-SP1 ST491B	35, 37 37
T2DD 065	T2DD 065/Q	T2DD 065	15
T2ED 045	T2ED 045	T2ED 045	14
T2ED 050	T2ED 050	T2ED 050	14
T2EE 060	T2EE 060	T2EE 060	14
T4CB 100	T4CB 100	T4CB 100	16
TG1603KRR50-A	PER.TG1603RRR50-A	BBTG1603KRR50	58
UC205-25MM-AP	PER.UCN205A	205G PEER UC205-25MM-AP	50
UC206-30MM-AP	PER.UCN206A	206G PEER UC206-30MM-AP	50
UC207-35MM-AP	PER.UCN207A	UC207-35MM-AP 207G	51
UC208-40MM-AP	PER.UCN208A	UC208-40MM-AP	51
UC209-45MM-AP	PER.UCN209A	209G UC209-45MM-AP	51
UCF208A-C-40MM	PER.UCF208A-C	208 Xtreme UC208-40MM-AP	35
UCFX11-32	PER.UCFX11-32A-A	212G UCX11-32-AP	35
UCFX12-38	PER.UCFX12-38A-A	213G UCX12-38-AP	35
UCFX13-65MM	PER.UCFX13AT-B	214T UCX13-65MM-AP	35
UCNF208A-A-40MM	PER.UCNF208A-A	208MF UC208-40MM	35
UCNF208A-B-40MM	PER.UCNF208A-B	208 Xtreme UC208-40MM-AP	35
UCNF209-45MM	PER.UCNF209A-A	209 Xtreme UC209-45MM-AP	35
UCNF210A-A-50MM	PER.UCNF210A-A	210 Xtreme UC210-50MM-AP	35
UCNF210A-B-50MM	PER.UCNF210A-B	210 TILLXtreme UC210-50MM-AP	35
UCNFC214-70MM	PER.UCNFC214A-A	214 TILLXTREME UC214-70MM-AP	35
UCNFS210A-A-50MM	PER.UCNFS210A-A	210 Xtreme UC210-50MM-AP	35
UCNFS210A-B-50MM	PER.UCNFS210A-B	210 Xtreme UC210-50MM-AP	35
UCNFT206A-A-30MM	PER.UCNFT206A-A	206 UC206-30MM-AP	35
UCNFT206A-B-30MM	PER.UCNFT206A-B	206 UC206-30MM-AP	35
UCNFT208A-A-40MM	PER.UCNFT208A-A	208 UC208-40MM	35
UCNFT208A-B-40MM	PER.UCNFT208A-B	208 Xtreme UC208-40MM-AP	35
UCR208-24-TRL	PER.UCR208-24AT-A	208T UCR208-24-AP	57
UCR209-39-TRL	PER.UCR212-39AT-A	212T UCR212-39-AP	57
W204HRRB2	PER.W204HRRB2	W204HRRB2	45
W207-35MM-FTDT-MF-AP	PER.W207RPPB61-FT-A	207 Xtreme W207-35MM-MF	35
W208HYYB60	PER.W208HYYB60	W208HYYB60	57
W208KPP53	PER.W208RPP53	W208KPP53	57
W208KRRB6	PER.W208HRRB6	W208KRRB6	57
W208PP10	PER.W208RPP10	W208PP10	33
W208PP21	PER.W208HPP21	W208PP21	57
W208PP5	PER.W208SPP5	W208PP5	33
W208PP6	PER.W208SPP6	W208PP6	33
W208PP8	PER.W208SPP8	W208PP8	33
W208PPB16	PER.W208HPPB16	W208PPB16	49
W208PPB23	PER.W208RPPB23	W208PPB23	33
W208PPB5	PER.W208SPPB5	W208PPB5	33
W208PPB6	PER.W208SPPB6	W208PPB6	33
W208PPB7	PER.W208RPPB7	W208PPB7	33
W208PPB8	PER.W208SPPB8	W208PPB8	33
W208RPPB10	PER.W208RPPB10	W208RPPB10	57
W209PPB2	PER.W209RPPB2	W209PPB2	33
W209PPB4	PER.W209RPPB4	W209PPB4	33
W209PPB5	PER.W209SPPB5	W209PPB5	33
W210	PER.W210R	W210	33
W210-50MM-MF-R-DF-A165	PER.W210RPPB55-F-A	210	35
W210-50MM-MF-R-DF-A490	PER.GW210RPPB55-F-B	210 XTREME W210-MF	35
W210PP10	PER.W210RPP10	W210PP10	33
W210PP2	PER.W210RPP2	W210PP2	33

Industry designation	SKF designation	Part Marking	Page
W210PP4	PER.W210SPP4-A	W210PP4	33
W210PPB2	PER.W210RPPB2	W210PPB2	33
W210PPB4	PER.W210SPPB4	W210PPB4	33
W210PPB5	PER.W210RPPB5	W209PPB5	33
W211K56-7L-DTTU	PER.W211RNN56-TTU	W211K56-7L	34
W211K56-7L-TTU	PER.W211RNN56-TTU-A	W211K56-7L	34
W211K58-TTU	PER.W211RSS58-TTU	W211K58	34
W211K59-TTU	PER.W211SS59-TTU	W211K59	34
W211KRRB50	PER.W211HRRB50	W211KRRB50	49
W211PP2	PER.W211RPP2	W211PP2	33
	PER.W211RPP2-A	W211PP2	33
W211PP3	PER.W211SPP3	W211PP3	33
W211PP5	PER.W211SPP5	W211PP5	33
W211PP54	PER.W211RPP54	W211PP54	33
W211PPB2	PER.W211RPPB2	W211PPB2	33
W211PPB3	PER.W211SPPB3	W211PPB3	33
W211PPB4	PER.W211RPPB4	W211PPB4	33
W211PPB6	PER.W211SPPB6	W211PPB6	33
W212-60MM-MF-DF	PER.W212RPPB54-F-A	212 Xtreme W212-MF	35
W214K51-TTU-HANGER-SP1	PER.W214RSS51-TTUHG	W214K51-TTU	34
W214K54-7L-DTTU	PER.W214SNN54-TTU	W214K54-7L	34
W214K60-7L-DTTU-HANGER	PER.W214SNN60-TTUHG	W214K60-7L	34
W215KPP52	PER.W215HPP52	W215KPP52	57
W308-40MM-MF-R-DF	PER.W308RRPB52-F-A	W308-MF	35
W312KPP51	PER.W312HPP51	W312KPP51	57
W5203RYY59	PER.W5203RYY59	W5203RYY59	44
W5204-2RSTFP-C3-TN	PER.W5204-2RSTFPC3G6	W5204RSTFP	43
W5204RP52-D	PER.5204RP52-A	5204RP52-A	44
W5204RRY62	PER.W5204RRY62	W5204RRY62	44
W5207HRRB60	PER.W5207HRRB60	W5207HRRB60	48
W5207HRRB60-A	PER.W5207RRRB60-A	W5207HRRB60	48
WBB205RPP60-A	PER.WBB205RPP60-A	WBB205RPP60-A	43
WBB205RPP62	PER.WBB205RPP62	WBB205RPP62	42
WP5203-KRP2-N	PER.WP5203NRP2	WP5203-KRP2	44
XD-UCTFU312-39-AP-TLTL-U329	PER.UCNTFU312-39AS-A	UC312-39-AP TFU-312-XH	36
YAR 205-2DW/AG	YAR 205-2DW/AG	YAR 205-2DW/AG	50
YAR 206-2DW/AG	YAR 206-2DW/AG	YAR 206-2DW/AG	50
YAR 207-DW/AG	YAR 207-DW/AG	YAR 207-DW/AG	51
YAR 208-2DW/AG	YAR 208-2DW/AG	YAR 208-2DW/AG	51
YAR 209-2DW/AG	YAR 209-2DW/AG	YAR 209-2DW/AG	51
YEL 205-100-2DW/AG	YEL 205-100-2DW/AG	YEL 205-100-2DW/AG	50
YEL 205-2DW/AG	YEL 205-2DW/AG	YEL 205-2DW/AG	50
YEL 206-102-2DW/AG	YEL 206-102-2DW/AG	YEL 206-102-2DW/AG	50
YEL 206-103-2DW/AG	YEL 206-103-2DW/AG	YEL 206-103-2DW/AG	50
YEL 206-2DW/AG	YEL 206-2DW/AG	YEL 206-2DW/AG	50
YEL 207-104-2DW/AG	YEL 207-104-2DW/AG	YEL 207-104-2DW/AG	50
YEL 207-106-2DW/AG	YEL 207-106-2DW/AG	YEL 207-106-2DW/AG	51
YEL 207-107-2DW/AG	YEL 207-107-2DW/AG	YEL 207-107-2DW/AG	51
YEL 207-DW/AG	YEL 207-DW/AG	YEL 207-DW/AG	51
YEL 208-108-2DW/AG	YEL 208-108-2DW/AG	YEL 208-108-2DW/AG	51
YEL 208-2DW/AG	YEL 208-2DW/AG	YEL 208-2DW/AG	51
YEL 209-111-2DW/AG	YEL 209-111-2DW/AG	YEL 209-111-2DW/AG	51
YEL 209-112-2DW/AG	YEL 209-112-2DW/AG	YEL 209-112-2DW/AG	51
YEL 209-2DW/AG	YEL 209-2DW/AG	YEL 209-2DW/AG	51
Z206-KRR52-H	PER.206HRR52-A	206KRR52	45



[skf.com](https://www.skf.com)

© SKF, SKF EXPLORER and PEER are registered trademarks of the SKF Group.

© SKF Group 2020

The contents of this publication are the copyright of the publisher and may not be reproduced (even extracts) unless prior written permission is granted. Every care has been taken to ensure the accuracy of the information contained in this publication but no liability can be accepted for any loss or damage whether direct, indirect or consequential arising out of the use of the information contained herein.

PUB 46/P1 18686/2 EN - March 2021

This publication supersedes publication PUB 46 / P2 17659 EN, PUB 46 / P1 18096 EN and AG CAT ENG LETTERV3_042018_PEER.

Certain image(s) used under license from Shutterstock.com.