

# TIMKEN

Where You Turn



Maintenance Tools



# Less Friction. More Solutions.

With more than 100 years of experience in bearing technology, Timken understands the importance of proper maintenance procedures in maximizing product and equipment life. High-quality Timken maintenance products help to decrease downtime and operating costs.

Our line of maintenance tools are an example of how we extend beyond bearings with friction management solutions to keep your business running smoothly. These value-added products are grounded in our knowledge of motion, lubrication, friction and metallurgy. They are designed to help you extend bearing life in your applications through proper installation, removal and service.

For more than 100 years, Timken has provided quality products to the industrial marketplace. Our field support team is available to help you use these tools appropriately, as well as identify other Timken solutions that may boost your productivity and save you money.

Through our products, programs and services, we're providing less friction and more solutions to help you achieve greater success.

For more information, contact your local Timken distributor or sales representative.





## **Installation Tools**

<b>INDUCTION HEATERS</b> .....	<b>4</b>
<b>IMPACT FITTING TOOLS</b> .....	<b>14</b>

## **Removal Tools**

<b>HYDRAULIC &amp; SELF-CENTERING HYDRAULIC PULLERS</b> .....	<b>18</b>
<b>MECHANICAL PULLERS</b> .....	<b>20</b>

<b>Accessories</b> .....	<b>23</b>
--------------------------	-----------

**WARNING:**

Proper maintenance and handling practices are critical. Failure to follow user manual can result in equipment failure, creating a risk of serious bodily harm.



**DO NOT WEAR  
METAL OBJECTS  
OR WATCHES.**



**USE HEAT  
PROTECTIVE  
GLOVES.**



**PROHIBITED FOR  
PEOPLE WITH  
A PACEMAKER  
AND/OR HEARING  
AID.**



**CAUTION**



**READ THE  
INSTRUCTIONS.**

**DO NOT OPERATE AN  
INDUCTION HEATER IN  
AREAS WHERE THERE IS A  
RISK OF AN EXPLOSION.**

# INSTALLATION TOOLS



## INSTALLATION TOOLS

# Induction Heaters

Timken offers a large assortment of high-quality induction heaters designed for demanding industrial applications. They can heat and radially expand a wide variety of gears, rings, couplings, bearings and other components. All heaters are produced in accordance with International (IEC) and European (CE) health and safety requirements. They feature a microprocessor controlled power supply, automated time and temperature control and automatic demagnetization.



Induction heaters with this icon next to them means that it comes with a plug and is ready to use.



### Why choose an induction heater?

Induction heating is a superior, fast and controlled heating method. It is a safer and more environmentally friendly alternative to traditional heating methods such as ovens, oil baths or blow torches. These methods cause fumes or oil waste and are not recommended for personal health and safety.

Timken induction heaters use the principle of induction, similar to a transformer. The heater and yokes remain cool; only the work piece is heated. During the induction heating cycle, a certain degree of magnetism occurs. All Timken heaters demagnetize automatically after each heating cycle.

### Versatility, safety and quality.

Timken induction heaters can be used for heating gear wheels, bushings, couplings and other components. Proper mounting may lengthen the life span of your equipment, and controlled induction heating helps to prevent unnecessary damage.

Digital electronics provide optimum control during the heating process and automatically select the most efficient power supply to help ensure balanced and fast heating.

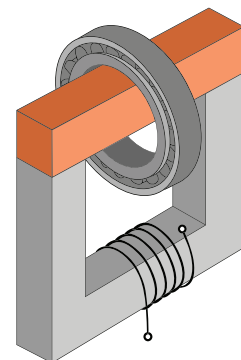

## MODELS



### VHIN10 Model

Portable design, easy to use, ideal for on-site jobs. Includes four yokes.

Min. Bore 15 mm (0.6")  
Max. O.D. 210 mm (8.3")  
Max. Width 120 mm (4.8")  
Max. Weight 15 kg (33 lbs.)



### VHIN33 Model

Powerful turbo design. Automatically selects the most effective power setting to ensure optimal and balanced heating.

Min. Bore 10 mm (0.4")  
Max. O.D. 350 mm (13.8")  
Max. Width 135 mm (5.3")  
Max. Weight 40 kg (88.2 lbs.)

*\* Not available in the U.S. or Canada*



### VHIN35 Model

Basic model with choice of four yokes. Picture at left shows optional vertical support arm.

Min. Bore 15 mm (0.6")  
Max. O.D. 480 mm (18.9")  
Max. Width 150 mm (5.9")  
Max. Weight 35 kg (77 lbs.)



### VHIS35 Model

This bench-top model features a unique swing arm for ergonomic working.

Min. Bore 15 mm (0.6")  
Max. O.D. 480 mm (18.9")  
Max. Width 150 mm (5.9")  
Max. Weight 35 kg (77 lbs.)

MODELS – CONTINUED

**POPULAR CHOICE**



**VHIS75 Model Turbo Design**

Plug & Heat turbo swing arm model.

Min. Bore 15 mm (0.6")  
Max. O.D. 750 mm (29.5")  
Max. Width 230 mm (9.1")  
Max. Weight 95 kg (209.4 lb)



**VHIS100 Model**

Large capacity bench-top model with swing arm.

Min. Bore 30 mm (1.2")  
Max. O.D. 720 mm (28.3")  
Max. Width 200 mm (7.9")  
Max. Weight 125 kg (275 lbs.)



**VHIS200 Model**

Mobile heavy-duty heater with unique swing arm.

Min. Bore 30 mm (1.2")  
Max. O.D. 1020 mm (40.2")  
Max. Width 265 mm (10.4")  
Max. Weight 250 kg (551 lbs.)



**VHIS300 Model**

Mobile heavy-duty heater with unique swing arm.

Min. Bore 30 mm (1.2")  
Max. O.D. 1020 mm (40.2")  
Max. Width 265 mm (10.4")  
Max. Weight 350 kg (772 lbs.)





## VHIS400 Models Turbo Design

Mobile extra-powerful heater with unique swing arm.

Min. Bore 60 mm (2.4")  
Max. O.D. 920 mm (36.2")  
Max. Width 350 mm (13.8")  
Max. Weight 550 kg (1,212 lbs.)



## VHIN550 Models

Powerful heater for exceptionally heavy components up to 600 kg (1,322 lbs.). Popular in workshops within steel mills, paper mills and gear box manufacturing. Heats parts in horizontal and vertical positions.

Min. Bore 85 mm (3.4")  
Max. O.D. 900 mm (35.4")  
Max. Width 400 mm (15.8")  
Max. Weight 600 kg (1,322 lbs.)



## VHIN800 Models

Powerful heater for exceptionally heavy components up to 1,250 kg (2,750 lbs.). Popular in workshops within steel, rail, wind, paper and gear box operations. Heats parts in horizontal and vertical positions.

Min. Bore 85 mm (3.4")  
Max. O.D. 1400 mm (55.1")  
Max. Width 420 mm (16.5")  
Max. Weight 1250 kg (2,750 lbs.)

*Contact your local Timken sales representative for assistance in building a custom solution for extremely large heaters.*

## INSTALLATION TOOLS • INDUCTION HEATERS

### Timken Induction Heaters Technical Data

Type	VHIN10	VHIN33	VHIN35
<b>ELECTRICITY</b>			
<b>Power Rating</b>	3.6 kVA	3.6 kVA	3.6 kVA
<b>Available Voltages</b>	120V • 20A	120V/230V • 20A	120V/230V • 20A
<b>Frequency</b>	50/60 Hz	50/60 Hz	50/60 Hz
<b>Swing Arm</b>	No	No	No
<b>Plug</b>	Yes	Yes	Yes
<b>WORK PIECE</b>			
<b>Max. Weight</b>			
- Bearings	15 kg (33.1 lbs.)	40 kg (88.2 lbs.)	35 kg (77.2 lbs.)
- Other Parts	10 kg (22.1 lbs.)	25 kg (55.1 lbs.)	20 kg (44.1 lbs.)
<b>Min. Bore Diameter</b>	15 mm (0.6")	10 mm (0.4")	15 mm (0.6")
<b>Max O.D.</b>	210 mm (8.3")	350 mm (13.8")	340/480 mm
<b>Vertical/Horizontal</b>			(13.39"/18.9")
<b>Max. Work Piece Width</b>	120 mm (4.8")	135 mm (5.3")	150 mm (5.9")
<b>POLE DIMENSIONS</b>			
<b>Area between the poles</b>	120 x 130 mm	135 x 135 mm	150 x 140 mm
<b>Width x Height</b>	(4.8" x 5.1")	(5.3" x 5.3")	(5.9" x 5.5")
<b>Pole Section</b>	40 mm (1.6")	95/40 mm	60 mm (2.4")
		(3.7" x 1.6")	
<b>Pole Height</b>	130 mm (5.1")	135 mm (5.3")	140 mm (5.5")
<b>CONTROLS</b>			
<b>Temperature Control</b>	150° C (302° F)	240° C (464° F)	240° C (464° F)
<b>Max. Temp</b>			
<b>Time Control</b>	0 – 30 Min.	0 – 45 Min.	0 – 45 Min.
<b>Max. Time</b>			
<b>Auto Power Reduction</b>	—	Automatically	—
<b>DIMENSIONS</b>			
<b>Dimensions</b>	435 x 225 x 275 mm (17.1" x 8.9" x 10.8")	600 x 220 x 275 mm (23.6" x 8.7" x 10.8")	340 x 290 x 310 mm (13.4" x 11.4" x 12.2")
<b>Package Size</b>	500 x 250 x 350 mm (19.7" x 9.8" x 13.8")	650 x 290 x 350 mm (25.6" x 11.4" x 13.8")	600 x 450 x 600 mm (23.6" x 17.7" x 23.6")
<b>Mass Heater Body (excludes yokes)</b>	21 kg (46.3 lbs.) (includes yokes)	23 kg (50.7 lbs.)	29 kg (63.9 lbs.)

Contact your Timken Representative for country-specific part numbers.

		VHIS35	VHIS75
		3.6 kVA 120V/230V • 20A 50/60 Hz Yes Yes	3.6 kVA 120V/230V • 15A 50/60 Hz Yes Yes
		35 kg (77.2 lbs.) 20 kg (44.1 lbs.) 15 mm (0.6") 340/480 mm (13.4"/18.9") 150 mm (5.9")	95 kg (209.4 lbs.) 50 kg (110.2 lbs.) 15 mm (0.6") 520/750 mm (20.5"/29.5") 230 mm (9.1")
		150 x 140 mm (5.9" x 5.5") 60 mm (2.4")  140 mm (5.5")	200 x 230 mm (7.9" x 9.1") 120/60 mm (2.4"/4.7") 230 mm (9.1")
		240° C (464° F)  0 – 45 Min.  —	240° C (464° F)  0 – 45 Min.  Automatically
		340 x 290 x 380 mm (13.4" x 11.4" x 15") 600 x 450 x 600 mm (23.6" x 17.7" x 23.6") 31 kg (68.3 lbs.)	440 x 370 x 360 mm (17.3" x 14.6" x 14.2") 700 x 500 x 700 mm (27.6" x 19.7" x 27.6") 38 kg (83.8 lbs.)

## INSTALLATION TOOLS • INDUCTION HEATERS

### Timken Induction Heaters Technical Data – CONTINUED

Type	VHIS100	VHIS200	VHIS300
<b>ELECTRICITY</b>			
<b>Power Rating</b>	8 kVA	12 kVA	24 kVA
<b>Available Voltages</b>	230V/400V/500V/600V • 20A	500V/900V • 32A	400V/500V/600V • 63A
<b>Frequency</b>	50/60 Hz	50/60 Hz	50/60 Hz
<b>Swing Arm</b>	Yes	Yes	Yes
<b>Plug</b>	–	–	–
<b>WORK PIECE</b>			
<b>Max. Weight</b>			
- Bearings	125 kg (275.6 lbs.)	250 kg (551.2 lbs.)	350 kg (771.6 lbs.)
- Other Parts	75 kg (165.4 lbs.)	150 kg (330.7 lbs.)	250 kg (551.2 lbs.)
<b>Min. Bore Diameter</b>	30 mm (1.2")	30 mm (1.2")	30 mm (1.2")
<b>Max O.D.</b>	480/720 mm	700/1020 mm	700/1020 mm
<b>Vertical/Horizontal</b>	(18.9"/28.3")	(27.6"/40.2")	(27.6"/40.2")
<b>Max. Work Piece Width</b>	200 mm (7.9")	265 mm (10.4")	265 mm (10.4")
<b>POLE DIMENSIONS</b>			
<b>Area between the poles</b>	200 x 180 mm	265 x 310 mm	265 x 310 mm
<b>Width x Height</b>	(7.9" x 9.1")	(10.4" x 12.2")	(10.4" x 12.6")
<b>Pole Section</b>	70 mm (2.8")	80 mm (3.2")	110 x 80 mm (4.3" x 3.2")
<b>Pole Height</b>	210 mm (8.3")	310 mm (12.2")	320 mm (12.60")
<b>CONTROLS</b>			
<b>Temperature Control</b>	240° C (464° F)	240° C (464° F)	240° C (464° F)
<b>Max. Temp</b>			
<b>Time Control</b>	0 – 60 Min.	0 – 99 Min.	0 – 99 Min.
<b>Max. Time</b>			
<b>Auto Power Reduction</b>	Automatically	Automatically	Automatically
<b>DIMENSIONS</b>			
<b>Dimensions</b>	630 x 365 x 470 mm (24.8" x 14.4" x 18.5")	950 x 640 x 1000 mm (37.4" x 25.2" x 39.4")	950 x 640 x 1000 mm (37.4" x 25.2" x 39.4")
<b>Package Size</b>	700 x 500 x 700 mm (27.6" x 19.7" x 27.6")	1140 x 750 x 1000 mm (44.9" x 29.5" x 39.4")	1140 x 750 x 1000 mm (44.9" x 29.5" x 39.4")
<b>Mass Heater Body (excludes yokes)</b>	53 kg (116.8 lbs.)	120 kg (264.55 lbs.)	175 kg (385.8 lbs.)

	VHIS400	VHIN550	VHIN800
	12 kVA 400V/500V • 32A 50/60 Hz Yes –	24 kVA 400V/500V • 63A 50/60 Hz No –	40 kVA 400V/500V • 100A 50/60 Hz No –
	550 kg (1,212.5 lbs.) 450 kg (992.1 lbs.) 60 mm (2.4") 920 mm (36.2")  350 mm (13.8")	600 kg (1,322.8 lbs.) 350 kg (771.6 lbs.) 85 mm (3.4") 900 mm (35.4")  400 mm (15.8")	1250 kg (2,750 lbs.) 750 kg (1,653.5 lbs.) 85 mm (3.4") 1400 mm (55.1")  420 mm (16.5")
	350 x 305 mm (13.8" x 12.0") 170/110 x 80 mm (6.7"/4.3" x 3.2") 305 mm (12.0")	390 x 400 mm (15.4" x 15.8") 100 mm (3.9")  390 mm (15.4")	660 x 420 mm (26.0" x 16.5") 150 mm (5.9")  660 mm (26.0")
	240° C (464° F)  0 – 99 Min.  Automatically	240° C (464° F)  0 – 99 Min.  Automatically	240° C (464° F)  0 – 99 Min.  Automatically
	1200 x 640 x 1000 mm (47.2" x 25.2" x 39.4") 1250 x 750 x 1000 mm (49.2" x 29.5" x 39.4")	1000 x 500 x 1350 mm (39.4" x 19.7" x 53.2") 1400 x 700 x 1600 mm (55.1" x 27.6" x 63.0")	1500 x 600 x 1470 mm (59.1" x 23.6" x 57.9") 1920 x 950 x 1720 mm (75.6" x 37.4" x 67.7")

## INSTALLATION TOOLS • INDUCTION HEATERS

# Choose Your Heater

### Induction Heater Selection Guide

The size and weight of your product will help determine which heater is right for your equipment. Please note that there is an overlap between models and that the model color on the left corresponds with the colors in the chart. The larger models offer faster product heating.

### Selection Guide Using Weight and O.D.

		O.D. Diameter									
<b>MODEL 800</b>	1400 mm (55")										
<b>MODEL 550</b>	900 mm (35.4")										
<b>MODEL 400</b>	920 mm (36.2")										
<b>MODEL 300</b>	1020 mm (40.2")										
<b>MODEL 200</b>	1020 mm (40.2")										
<b>MODEL 100</b>	720 mm (28")										
<b>MODELS 75</b>	750 mm (29.5")										
<b>MODELS 35</b>	480 mm (18.9")										
<b>MODEL 33</b>	350 mm (13.8")										
<b>MODEL 10</b>	210 mm (8.3")										
		0 kg (33 lbs.)	15 kg (33 lbs.)	35 kg (77 lbs.)	95 kg (209 lbs.)	125 kg (275 lbs.)	250 kg (550 lbs.)	350 kg (770 lbs.)	550 kg (1,210 lbs.)	600 kg (1,320 lbs.)	1250 kg (2,750 lbs.)
		<b>WEIGHT</b>									

For maximum width see technical specifications on pages 8-11.  
Timken will work with you to make sure you have the right plug for your heater and region.

## ORDER EXAMPLE

You need a work piece to heat fast for production use. The work piece has an O.D. of nine inches and weighs 16 pounds. You work in the U.S. and need a standard 120V-style plug. Using the chart at left, Timken recommends the VHIS75 model. The order number is VHIS754US.

### VHIS75



### Included With All Timken Heater Models

<b>Electronics</b>	Digital display	Temperature Time Error Report
	Sound signal	Yes
	Temperature hold	Yes
	Demagnetizing, <2A/cm	Yes
	Thermal safety guard	Yes
<b>Miscellaneous</b>	Magnetic temperature probe	Yes
	Yokes, different size	Yes <small>(except 550, 800 and 900 models)</small>
	Warranty, electronics	Three years
	400° F Heat-resistant gloves	Yes
	Instructions for proper use	Yes

## TECHNICAL HINTS

*The product heats too slow...*

We advise our customers to heat the work piece in a horizontal position around the pole if possible. This will bring more energy into the work piece since it is closer to the coil. Hanging the work piece on the yoke will create more distance between it and the coil which means less energy and slower heating time. If possible, always place the work piece around the coil to achieve the fastest heating results.

*"Handle" broke off...*

It's not a handle. It's the base support. It is there to support large O.D.'s that would otherwise hang over the side of the heater.

*When I start to heat the product, the part is loud and vibrates...*

Make sure you put some Vaseline or grease on the poles, yoke and the bore of the product you are heating. This improves the magnetic field. Please note that it may smoke when you heat the product.

The swing arm could be out of adjustment. Check the setscrew on the pole and adjust it so the yoke makes contact with both poles.

# Impact Fitting Tool

Care should be taken when mounting tapered roller bearings. The cup can be mounted in either direction, but the cone can only be mounted from the back face. This ensures that the cage does not overhang. Never mount a cup and cone together or mount a cone from the front face. This will avoid damage to the cage and raceways which could lead to catastrophic failure.

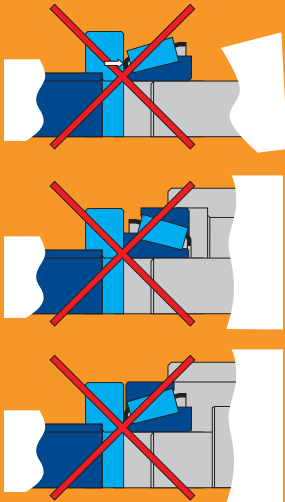

Proper mounting allows the load to be transmitted to the ring experiencing the interference fit. Mounting forces are not transmitted via the rolling elements, helping to prevent damage to the raceways.

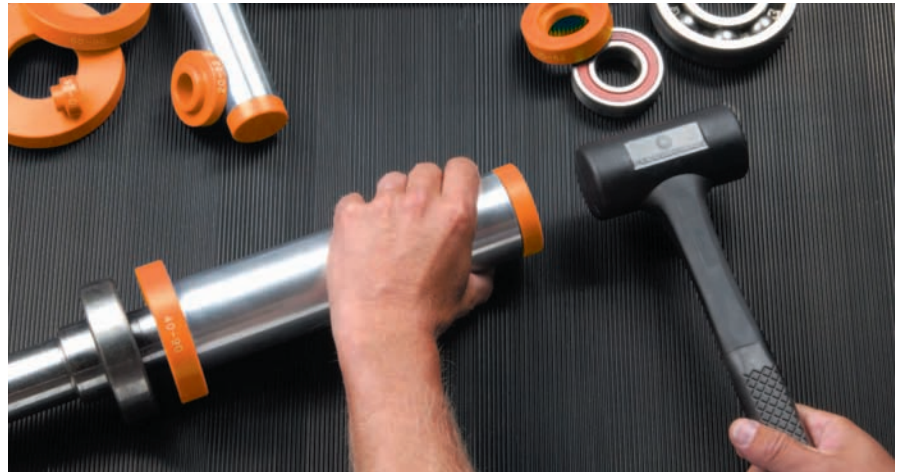
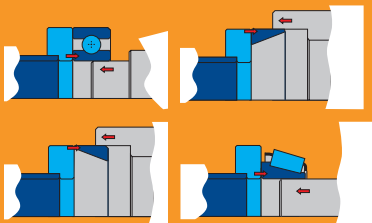

## Mounting

Proper mounting is essential to ensure long bearing life. Designed to permit the safe, precise and quick mounting of bearings, bushings, sealing rings, cam wheels and pulleys, the Timken impact fitting tool set features impact-resistant plastic collets. These help deter metal-to-metal contact and the resulting shaft damage.

During the mounting of bearings where the faces lie in the same plane, the collets enable the load to be transmitted to the ring experiencing the interference fit. If the impact mounting tool is used, mounting forces are not transmitted via the rolling elements and damage to the raceways is avoided.



## Impact Fitting Tool Warning

- When operating the impact fitting tool, please wear protective clothing, including safety shoes, protective glasses, gloves and helmet.
- Do not use the collets to mount components that have temperatures greater than 80° C (176° F).
- Never mount the cup and cone of a tapered bearing together or mount a cone from the front face.

## VIFT3300

This set includes:

- 33 collets ranging from 10 mm to 110 mm
- Three sleeves
- One impact hammer
- Case size: 16.9" x 12.6" x 4.0"





## Impact Fitting Tool Selection Guide

Sleeve	Ring	All ISO Bearing Codes Ending With	60, 62 63, 64	12, 22 13, 23	70, 72B 73B	32, 33	222, 213 223	NU, NJ N 2 3 4	302, 322 303, 330	320, 313 323, 332	
<b>A1</b>	10-26	000	6000	129	7000						
	10-30	200	6200	1200		3200					
			2200								
	10-35	300	6300	1300	7300						
	12-28	001	6001								
	12-32	201	6201	1201		3201					
			2201								
	12-37	301	6301	1301	7301						
			2301								
	15-32	002	6002								
	15-35	202	6202	1202	7202B	3202					
			2202								
	15-42	302	6302	1302		3302			30302		
			2302								
	17-35	003	6003								
			16003								
	17-40	203	6203	1203	7203B	3203			30203		
		2203									
17-47	303	6303	1303	7303B	3303			30303	32303		
		2303									
<b>B2</b>	20-42	004	6004		7004					32004	
	20-47	204	6204	1204	7204B	3204		204	30204		
			2204								
	20-52	304	6304	1304	7304B	3304	21304	304	30304	32304	
			403	6403	2304						
	25-47	005	6005		7005					32005	
	25-52	205	6205	1205	7205B	3205	22205	205	30205	33205	
			2205					32205			
	25-62	305	6305	1305	7305B	3305	21305	305	30305	31305	
			404	6404	2305					32305	
	30-55	006	6006							32006	
	30-62	206	6206	1206	7206B	3206	22206	206	30206	33206	
			2206					32206			
	30-72	306	6306	1306	7306B	3306	21306	306	30306	31306	
			405	6405	2206			405		32306	
	<b>C3</b>	35-62	007	6007		7007					32007
		35-72	207	6207	1207	7207B	3207	22207	207	30207	33207
			2207					32207			
35-80		307	6307	1307	7307B	3307	21307	307	30307	31307	
			406	6406	2307			406		32307	
40-68		008	6008							32008	
40-80		208	6208	1208	7208B	3208	22208	208	30208	33208	
								32208			
40-90		308	6308	1308	7308B	3308	21308	308	30308	31308	
			407	6407	2308		22308	407		32308	
45-75		009	6009							32009	
45-85		209	6209	1209	7209B	3209	22209	209	30209	33209	
			2209					32209			
45-100		309	6309	1309	7309B	3309	21309	309	30309	31309	
			408	6408	2309		22309	408		32309	
50-80		010	6010							33010	
50-90		210	6210	1210	7210B	3210	22210	210	30210	33210	
		2210					32210				
										JM205149/JM205110	
50-110	310	6310	1310	7310B	3310	21310	310	30310	31310		
		409	6409	2310		22310	409		32310		
	Impact rings 50-90, 45-100, 50-110 also fit the following bearing where only the outer ring is to be fitted, e.g., shaft not installed:										
<b>C3</b>	50-90		6011								
			6012								
	45-100		6013	1211	7211B	3211	22211	211			
			6211	2211	7212B						
	50-110		6014	1212	7213B	3212	22212	212			
			6015	1213		3213	22213	213			
			6212	2213		3211	21311	311			
			6213	2213			22311	410			
			6311	1311							
		6410	2311								

For tapered bearings, impact rings fit outer ring and also inner ring if driving from large-diameter side. The numbers on each impact ring (e.g., 25-62) are clearly marked on the ring. The first figure refers to shaft diameter, the second to bearing outer diameter.

### **Puller Warning**

- Check condition of puller before use.
- If there are indications of wear and tear such as ground-down parts, overloaded parts, or worn-out parts, exchange them with new parts.
- Do not use a hammer when operating spindle.
- If any indications of overload, stiff working, etc., occur during pulling, please stop the procedure at once. Try to use a larger or different type of puller if necessary.
- For proper puller engagement, the jaws/legs should be centered.
- When pulling, make sure puller and pulled parts are kept covered by the safety blanket to provide protection from injury caused by flying parts should a part ever break.
- When operating the puller, please wear protective clothing, including safety shoes, protective glasses, gloves and helmet.
- Spindle and puller body should always be kept clean and oiled.
- Make sure you avoid puller overload, as it can result in breakage of the puller's arms and/or beam. This breakage can cause damage to the puller, shaft and bearing as well as personal injury.

## REMOVAL TOOLS



# Hydraulic & Self-Centering Hydraulic Pullers

Timken carries a wide range of self-contained portable hydraulic and mechanical pulling systems that have capacities from four to 30 tons. They are ideal for removing all kinds of shaft-fitted parts.

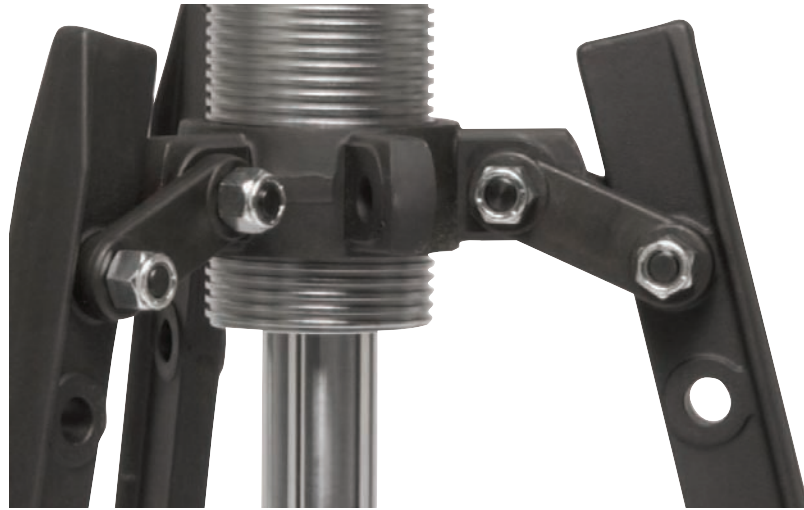

### Advantages

- Integrated pump, cylinder, hose and puller with safety-release valve.
- Compact design: The self-contained hydraulic pump and puller saves space.
- Sets are supplied in a handy carrying case.
- Multi-purpose: Ideal for pulling a wide variety of press-fit parts including bearings, wheels, bushings, gears and pulleys.
- The pump handle rotates 360-degrees, enabling users to pull from the most convenient position.
- Pullers can be used with two or three legs.
- Available with accessories.

**NEW**

### Self-Centering Hydraulic Pullers

The same power as our standard models, but with the added convenience of hand operation. No more fumbling to engage the puller to the part. Self-centering makes pulling shaft-fitting parts easy. Self-centering hydraulic pullers come preassembled.



# MODELS

## NEW Self-Centering Hydraulic Pullers



MODEL	Max. Withdrawal Force	Arm Length	Width of Grip	STROKE Width	A	B	C	D	E	F	G	MASS
<b>VHPS4</b>	4 t	190 mm (7.48")	325 mm (12.8")	60 mm (2.4")	13 mm (0.5")	10 mm (0.4")	22 mm (0.9")	-	40 mm (1.6")	42 mm (1.7")	22 mm (0.9")	8 kg (18 lbs.)
<b>VHPS6A</b>	6 t	230 mm (9.1")	380 mm (15")	70 mm (3.4")	13 mm (0.5")	10 mm (0.4")	22 mm (0.9")	-	50 mm (2")	45 mm (1.8")	23 mm (0.9")	10 kg (22 lbs.)
<b>VHPS8</b>	8 t	280 mm (11")	450 mm (17.7")	85 mm (3.4")	13 mm (0.5")	13 mm (0.5")	27.5 mm (1.1")	-	70 mm (2.7")	50 mm (2")	25 mm (1")	12 kg (26 lbs.)
<b>VHPS12</b>	12 t	305 mm (12")	485 mm (19.1")	85 mm (3.4")	15 mm (0.6")	17 mm (0.7")	29 mm (1.1")	-	70 mm (2.7")	60 mm (2.4")	28 mm (1.1")	15 kg (33 lbs.)
<b>VHPS20</b>	20 t	365 mm (14.4")	570 mm (22.4")	111 mm (4.4")	20 mm (0.8")	27 mm (1.1")	33 mm (1.3")	-	62mm (2.4")	80 mm (3.2")	40 mm (1.6")	25 kg (55 lbs.)
<b>VHPS30</b>	30 t	465 mm (18.3")	680 mm (26.8")	111 mm (4.4")	20 mm (0.8")	27 mm (1.1")	38 mm (1.5")	-	85 mm (3.3")	98 mm (3.9")	50 mm (2")	36 kg (80 lbs.)

## Hydraulic Pullers



MODEL	Max. Withdrawal Force	1	2	3	A	B	C	D	E	F	G	WEIGHT
<b>VHPT4</b>	4 t	185 mm (7.3")	275 mm (10.8")	60 mm (2.4")	11 mm (0.4")	6 mm (0.2")	22 mm (0.9")	32 mm (1.3")	84 mm (3.3")	42 mm (1.7")	22 mm (0.9")	4.5 kg (9.9 lbs.)
<b>VHPT6A</b>	8 t	230 mm (9.1")	350 mm (13.8")	85 mm (3.4")	11 mm (0.4")	10 mm (0.4")	25 mm (1.0")	51 mm (2.0")	122 mm (4.8")	50 mm (2.0")	25 mm (1.0")	6.5 kg (14.3 lbs.)
<b>VHPT8</b>	8 t	230 mm (9.1")	350 mm (13.8")	85 mm (3.4")	11 mm (0.4")	10 mm (0.4")	25 mm (1.0")	51 mm (2.0")	122 mm (4.8")	50 mm (2.0")	25 mm (1.0")	6.5 kg (14.3 lbs.)
<b>VHPT12</b>	12 t	270 mm (10.6")	375 mm (14.8")	85 mm (3.4")	14 mm (0.6")	10 mm (0.4")	29 mm (1.1")	51 mm (2.0")	118 mm (4.6")	60 mm (2.4")	28 mm (1.1")	8 kg (17.6 lbs.)
<b>VHPT20</b>	20 t	360 mm (14.2")	520 mm (20.5")	111 mm (4.4")	20 mm (0.8")	27 mm (1.1")	33 mm (1.3")	60 mm (2.4")	161 mm (6.3")	80 mm (3.2")	40 mm (1.6")	22 kg (48.5 lbs.)
<b>VHPT30</b>	30 t	360 mm (14.2")	550 mm (21.7")	111 mm (4.4")	20 mm (0.8")	27 mm (1.1")	38 mm (1.5")	60 mm (2.4")	155 mm (6.1")	98 mm (3.9")	50 mm (2.0")	32 kg (70.6 lbs.)

# Mechanical Pullers



After the required type of puller has been identified, it is easy to choose the most suitable model from the series listed in the catalog.

Please note: Understanding the work space and possibility of gripping will insure proper fit of grip.

Compare size and measurement of the part to be removed to the values indicated in the table to choose the suitable puller. The choice of mechanical puller depends also on required pulling force.

The most important factor is safety; make sure to always choose a larger or stronger puller. Three-arm pullers better distribute the pulling force than two-arm devices, therefore, if there is enough space, three-arm pullers should be the first choice.

For safety purposes and service life of the puller, never exceed the maximum capacity. The capacity data has been determined for new pullers. Normal wear and tear in practice and damage may decrease these figures.

**NEW**

## Mechanical 3-Jaw Pullers

For economical-minded maintenance professionals, Timken offers a simple to use mechanical line of pullers. Our mechanical pullers have a self centering feature – making life easier for you.

# MODELS

## Mechanical Pullers



MODEL	Max. Withdrawal Force	Arm Length	Width of Grip	STROKE Width	A	B	C	D	E	F	G	MASS
<b>VMPS2</b>	2 t	80 mm (3.1")	120 mm (4.7")	-	8.3 mm (0.3")	6 mm (0.2")	15 mm (0.6")	-	-	-	16 mm (0.625")	1.6 kg (3.5 lbs.)
<b>VMPS3</b>	3 t	120 mm (4.7")	180 mm (7.1")	-	6 mm (0.2")	7 mm (0.3")	15 mm (0.6")	-	-	-	16 mm (0.625")	2.3 kg (5.1 lbs.)
<b>VMPS5</b>	5 t	160 mm (6.3")	270 mm (10.6")	-	11 mm (0.4")	10 mm (0.4")	25 mm (1")	-	-	-	19 mm (.75")	4.3 kg (9.5 lbs.)
<b>VMPS8</b>	8 t	210 mm (8.3")	300 mm (11.8")	-	13 mm (0.5")	14 mm (0.6")	27 mm (1.1")	-	-	-	19 mm (.75")	6.1 kg (13.4 lbs.)

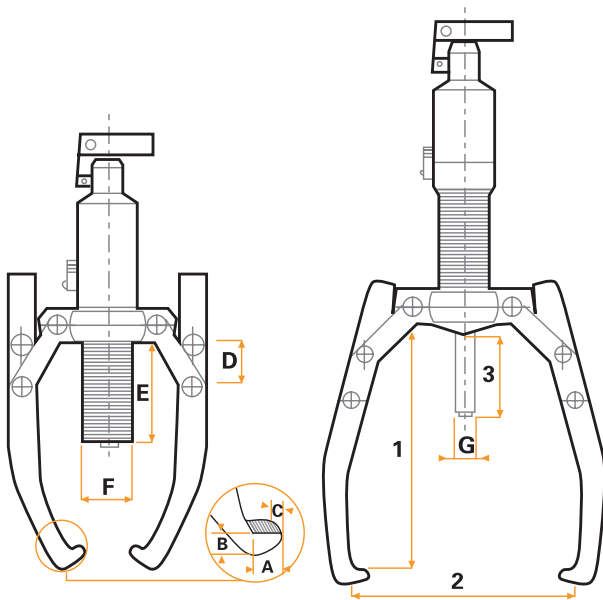

- 1 – Reach
- 2 – Spread
- 3 – Stroke





# ACCESSORIES



**ACCESSORIES • INDUCTION HEATERS**

# Induction Heaters

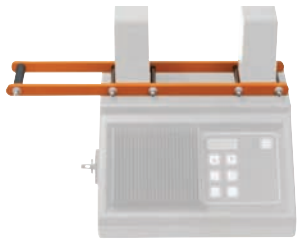

**Sliding Support**

Sliding support for VHIS 400 for heating in vertical position.



**Hammer**



**Gloves**



**Support**

Support for VHIS 35 for heating in vertical position included with the VHIS 353US.

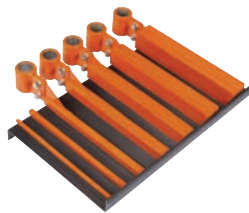

**Yoke Set**



**Temperature Probe**

Each Timken induction heater model is supplied with a magnetic temperature probe. A clamp also is available for nonferrous components. Replacement probes, part number VHIA 100001, can be purchased separately.

**ACCESSORIES • HYDRAULIC PULLERS**

# Hydraulic Pullers



**Accessories Set**

For use with up to and including 12 tons. These accessory sets are supplied without the hydraulic pump. Use the hydraulic pump off the puller set.

**Splitter Accessory Sets (Hydraulic Pump Not Included)**

*Fits both self-centering and standard hydraulic pullers.*

MODEL	Puller	Arm Length	Width of Grip	Min. O.D.	Max. O.D.	Weight
VHPT490*	VHPT4	250 mm (9.8")	110 mm (4.3")	25 mm (1.0")	110 mm (4.3")	8.5 kg (18.7 lbs.)
VHPT690A*	VHPT6	280 mm (11.0")	220 mm (8.7")	50 mm (2.0")	150 mm (5.9")	12.5 kg (21.6 lbs.)
VHPT890*	VHPT8	280 mm (11.0")	210 mm (8.3")	50 mm (2.0")	150 mm (5.9")	12.5 kg (21.6 lbs.)
VHPT1290*	VHPT12	325 mm (12.8")	290 mm (11.4")	80 mm (3.2")	225 mm (8.9")	18 kg (39.7 lbs.)

\* Will work with VHPT/VHIS series.

# Safety Instructions

## WARNING:

Proper maintenance and handling practices are critical. Failure to follow user manual can result in equipment failure, creating a risk of serious bodily harm.

## Induction Heater Warning



**DO NOT WEAR METAL OBJECTS OR WATCHES.**



**PROHIBITED FOR PEOPLE WITH A PACEMAKER AND/OR HEARING AID.**



**READ THE INSTRUCTIONS.**



**USE HEAT PROTECTIVE GLOVES.**



**CAUTION**

**DO NOT OPERATE AN INDUCTION HEATER IN AREAS WHERE THERE IS A RISK OF AN EXPLOSION.**

## Hydraulic Puller Warning

- Check condition of puller before use.
- If there are indications of wear and tear such as ground-down parts, overloaded parts, or worn-out parts, exchange them with new parts.
- Do not use a hammer when operating spindle.
- If any indications of overload, stiff working, etc., occur during pulling, please stop the procedure at once. Try to use a larger or different type of puller if necessary.
- For proper puller engagement, the jaws/legs should be centered.
- When pulling, make sure puller and pulled parts are kept covered by the safety blanket to provide protection from injury caused by flying parts should a part ever break.
- When operating the puller, please wear protective clothing, including safety shoes, protective glasses, gloves and helmet.
- Spindle and puller body should always be kept clean and oiled.
- Make sure you avoid puller overload, as it can result in breakage of the puller's arms and/or beam. This breakage can cause damage to the puller, shaft and bearing as well as personal injury.

## Impact Fitting Tool Warning

- When operating the impact fitting tool, please wear protective clothing, including safety shoes, protective glasses, gloves and helmet.
- Do not use the collets to mount components that have temperatures greater than 80° C (176° F).
- Never mount the cup and cone of a tapered bearing together or mount a cone from the front face.



**WARNING:**

Proper maintenance and handling practices are critical. Failure to follow user manual can result in equipment failure, creating a risk of serious bodily harm.

**TIMKEN**  
Where You Turn

Bearings • Steel •  
Precision Components • Lubrication •  
Seals • Remanufacture and Repair •  
Industrial Services  
[www.timken.com](http://www.timken.com)

Timken® is a registered trademark of  
The Timken Company

© 2007 The Timken Company  
Printed in U.S.A.  
10M 06-07-29 Order No. 7710