



**MachLine®:  
the perfect solution  
for your machine tools**

# **machline®**



425 450 475 0.010  
0.008  
0.006  
0.004  
0.002  
0.000  
-0.002  
-0.004  
-0.006  
-0.008  
-0.010  
-0.008  
-0.006  
-0.004  
-0.002  
0.000  
0.002  
0.004  
0.006  
0.008  
0.010

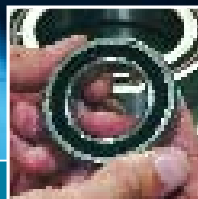

**Industry**





**Our expertise made available  
for your machine tools**

**mechline<sup>®</sup>**

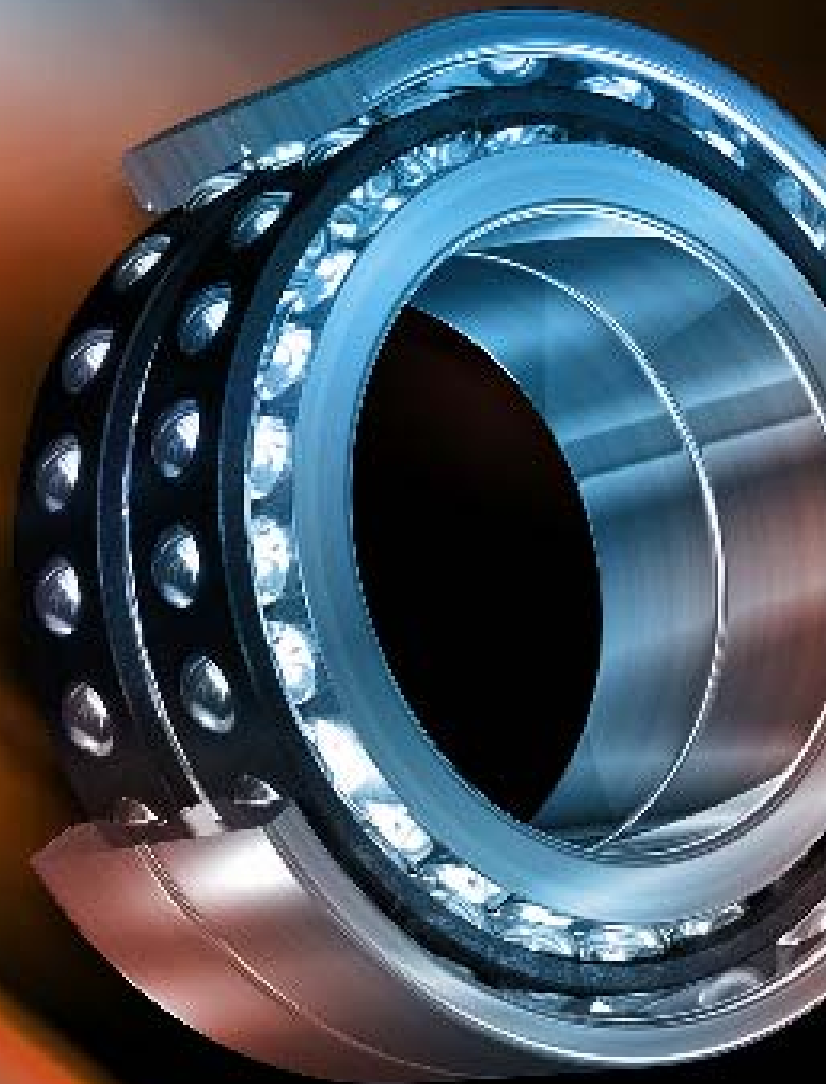

# Contents



## Everything there is to know about MachLine®

4 >10

- > *MachLine: meeting every challenge for machine tool spindles* 6
- > *Research & Development* 7
- > *The range* 8-10

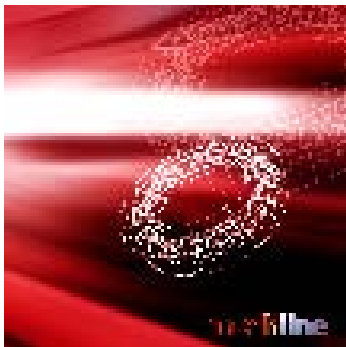

## General technical details

11 >36

- > *Preloading, definition of symbols* 12-14
- > *Rigidity, axial deflection* 15
- > *Influence of an external axial load* 16
- > *Speed correction factor* 17
- > *Spindle design* 18-24
- > *Lubrication* 25-27
- > *Selection guide* 28-29
- > *Ceramic ball bearings (CH)* 30-31
- > *High speed bearings (ML)* 32
- > *Sealed bearings (MLE)* 33
- > *HNS bearings (N)* 34
- > *Assembly examples* 35-36



## MachLine® range

37 >60

- > *Symbols, labelling and packaging* 38-39
- > *MachLine: the ranges* 40-51
- > *Precision self-locking nuts* 52-54
- > *Summary of the ranges* 55
- > *Tolerances and precision classes* 56-60



## Maintenance and services

61 >68

- > *Storage* 62
- > *Assembly* 63-66
- > *Vibratory analysis* 67
- > *Expert analysis, training* 68



## Precision, speed, quality: the best of all worlds

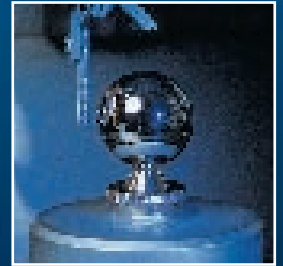

*SNR's engineers, through their partnership in ambitious projects such as Ariane 5 and the Airbus A380, have been working for forty years to meet the toughest technical challenges, with extremely high quality requirements. They have drawn on all their expertise to satisfy strict specifications and to operate in extraordinary speed and temperature conditions. On the basis of its experience in these conditions, SNR can now offer you the very best of its know-how for your machine tools. This is our manufacturing philosophy, and our MachLine bearings are the result. "Programmed" to guarantee you outstanding precision, performance and long life.*

## **SNR is part of the history of bearings... and is building their future**

SNR is a major player on the European and worldwide stage, and has consistently remained committed to innovation in product design and manufacturing. Its process management operations compliment a sales presence in more than 200 countries.

However, SNR is also closely associated with the development of mechatronics. The company was in the vanguard of mechatronics pioneers, developing a specific competence working with customers in the three major markets of automotive, aerospace and industry.



## **Precision benefits from good organization**

Very high precision bearings such as MachLine are designed, manufactured and tested by our aeronautics division which by its very nature, must have a “zero tolerance” organizational structure, when it comes to defects.



## **Quality: the safest bearings... and the most environmentally friendly**

MachLine bearings comply with the most stringent standards in terms of manufacturing quality and environmental protection, with ISO 9001-V2000, EN 9100 and ISO 14001 accreditation.



**machline**







Everything there  
is to know about

## **MachLine<sup>®</sup>**

*How have machine tool-specific requirements  
been accounted for in SNR's R&D?*

*What product families make up the MachLine  
range? What are their general characteristics?*

*Find the answers to these questions and more  
over the next few pages ...*

- MachLine: meeting every challenge for machine tool spindles 6
- Research & Development 7
- The range 8-10

**machline<sup>®</sup>**



# MachLine®: meeting every challenge for machine tool spindles

*Faster, cleaner, longer lasting: today's bearings need to be adapted to the reality of machining in today's world. High speed machining, reduction of downtime, greater rigidity and integrated sealing...*

*Machines are achieving ever increasing performance levels requiring productivity and environmental considerations to be considered.*

*The MachLine range has specific solutions for all these points.*

## | The challenge of reliability

The MachLine range offers a selection of new innovative products so that you no longer have to choose between machining speed and load capacity. In addition, precision self-locking nuts are offered to ensure proper assembly. These products enhance the "standard" high precision ranges which are still available and displayed in this catalog:

- *MachLine High Precision: Standard*
- *MachLine ML: High Speed*
- *MachLine CH: Hybrid*
- *MachLine MLE: Sealed bearings*
- *MachLine N: HNS*
- *Precision self-locking nuts*

## | The challenge of speed

Machining time is money. The quicker a machine works, the more productive it is. To achieve higher performance, bearings must be able to accommodate extremely high speeds – and this is why the ML range was designed.

## | The challenge of simplicity

A user's life is made easier if no periodic greasing is required: the MLE range of sealed bearings are lubricated for life.

*Enhanced performance with ceramic balls:*

**↗ x3** *times longer life*

**↗ +30%** *faster*

**↗ +10%** *more rigid*



*All MachLine range bearings are manufactured with a radial run-out whose precision meets ISO2 (ABEC 9) standards (Precision P4S).*



## | SNR R&D: high performance for your machine tools

*The research that SNR has put into the MachLine range covers all performance-related areas, from materials to bearing geometry and complementary functions.*

### - Steel:

Defects due to steel quality are extremely rare on MachLine bearings because SNR uses total procurement management and traceability systems for its products throughout the world. This guarantees high purity, the secret for long bearing life.

### - Lubrication and sealing:

SNR has developed "life-long" lubrication solutions, including LubSolid, which is a solution specially designed for certain industrial applications. It has been one of SNR's major research areas for MachLine, in order to allow high speeds, improve sealing and thus protect the mechanical environment.



*Medium-sized balls, providing a better balance between maximum speed and load capacity.*

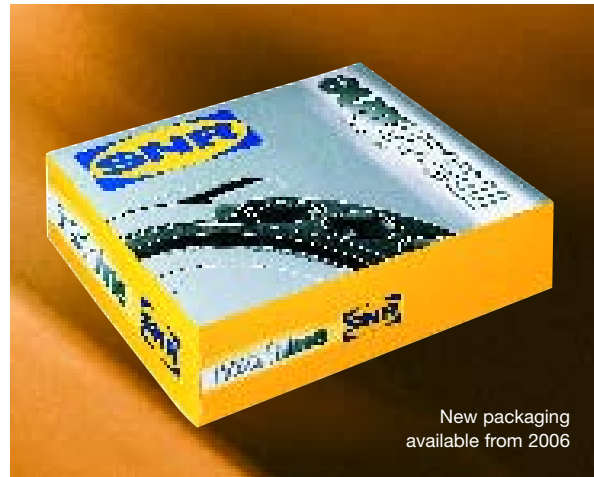

New packaging available from 2006

### - Defect simulation:

In this area, SNR's test center is particularly effective and has many years of experience. MachLine has undergone a vast array of tests and undergone numerous simulations and in-depth vibratory analysis.

### - Research into bearing instrumentation:

The future of machine tools is in microelectronics, magnetism and machine-based firmware and this is why SNR's R&D department is continuing to carry out research into upgrades for MachLine products in the area of mechatronics.

### - Contribution of fundamental and applied research:

As with all of SNR's ranges, MachLine has benefited from the company's active participation in European research programs, along with the largest worldwide steel manufacturers and major university research centers.

*2.2 million N.Dm: extremely high speeds have been achieved with the ML range.*

**machLine**





# MachLine®: a vast array of solutions



## HIGH PRECISION

- SNR series 71900V and 7000V, with excellent performance data to balance the need for speed, rigidity, capacity and precision.
- Series 7200G1, specially designed to meet specifications set by applications with large, predominantly axial loads.
- Variations according to contact angle (C for 15° and H for 25°) and preload (light, medium or heavy).



## HYBRID, CERAMIC BALLS CH

- Possible variation for all ranges, all series and all dimensions with Silicon Nitride balls and steel rings, combining the best qualities of the two materials.
- Reduced operating temperature and increased top speed. Reduced lubrication requirements as compared to a "conventional steel" bearing.
- Increased rigidity and longer life.

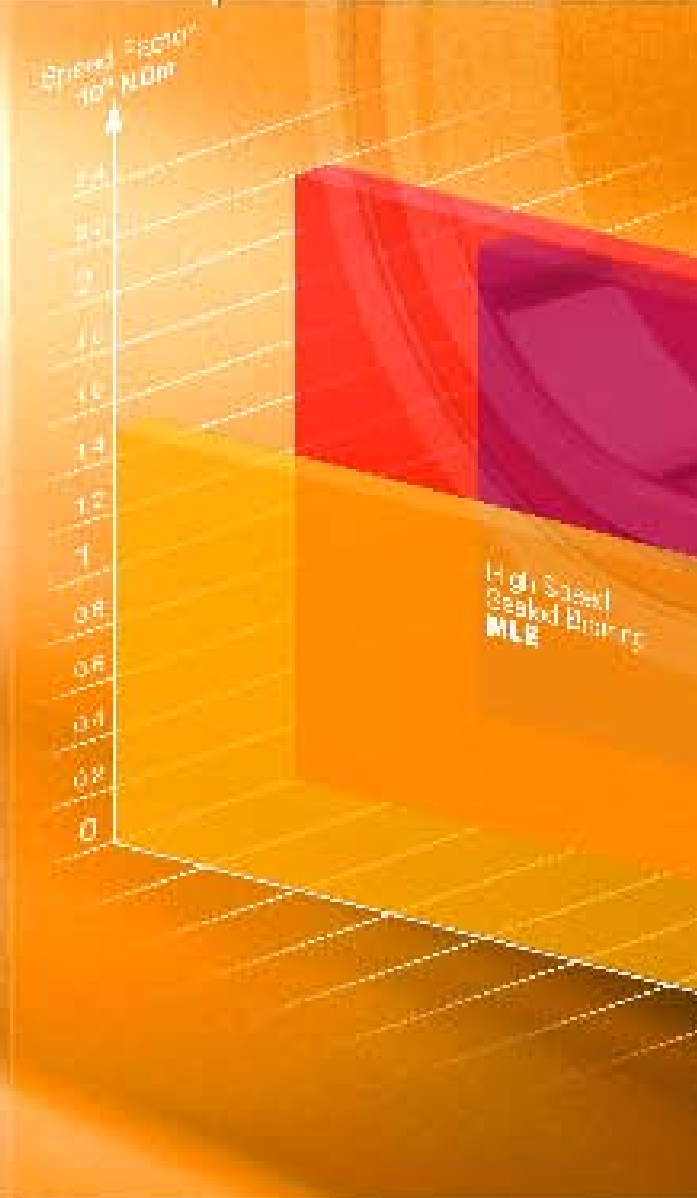

**Manufacturing standard:**

Whatever the machine tool application,  
there is a perfect MachLine solution.

**MachLine range operating domain for a bearing with same bore diameter**

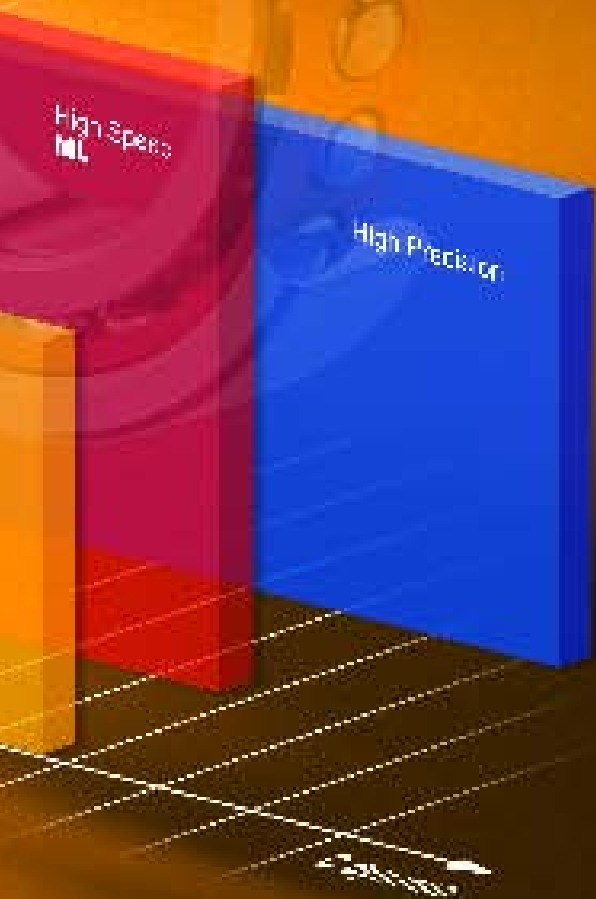

*Manufacturing precision 4S as standard (ISO 2, ABEC 9, for all rotation dynamic characteristics and ISO 4, ABEC 7, for all others).*



## HIGH SPEED ML

**Speed**  
+ 30 %

- Family made up of series 71900 and 7000, designed and developed by SNR to meet the increasingly stringent requirements in high speed mechanization.
- Specially designed geometry: reduction in ball diameter, increase in number of balls and optimization of cage guidance on outer ring.
- Different variations according to contact angle (C for 17° and H for 25°) and preload.



## HIGH SPEED SEALED BEARING MLE

**Non-contact sealing**

- When oil lubrication is not required and grease lubrication is sufficient, SNR has a technically appropriate solution which is also economically attractive – the MLE family of bearings, series 71900 and 7000.
- With nitrile rubber seals on the outer ring, not in contact with the inner ring, the same top speed can be attained as with an open bearing lubricated with grease.
- Variations according to contact angle (C for 17° and H for 25°) and preload.

**machline**





# MachLine®: a vast array of solutions

## | HNS bearings: N

*This bearing is a direct result of SNR's aeronautical know-how and its performance data for machine tools are remarkable:*

- Increased rotation speeds,
- Better fatigue resistance,
- More reliable even when poorly lubricated,
- Longer life,
- Corrosion resistant.

**Characteristics:**

Bearings made of stainless martensitic steel with nitrogen (material used in aeronautics).

- Rings made of XD15N.
- Ceramic balls.



## | Precision self-locking nuts

*Available in narrow or wide gauge, with a choice of 2 or 4 locking inserts, using blind holes or slots, the SNR range of precision self-locking nuts covers all requirements on the market.*

**These products are vital:**

- for all precision bearing assemblies,
- when a set of bearings need a guaranteed preload, which can be maintained over time,
- for high axial loads.



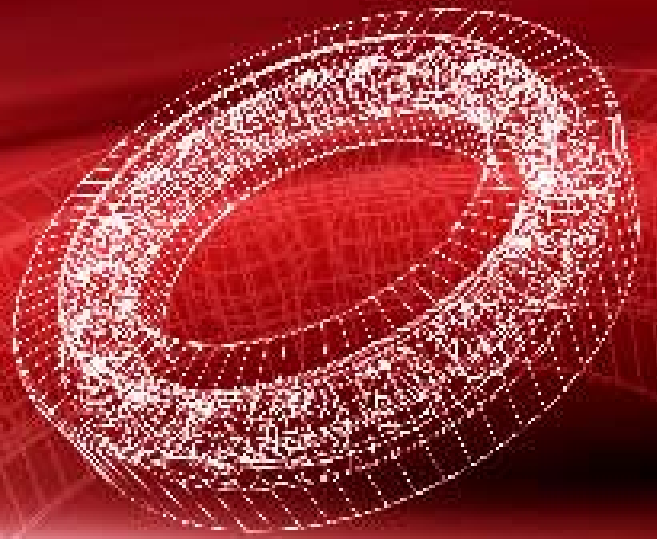

# General technical details

*Each application has its own specific speed and load requirements, with a significant impact on geometry, material or lubrication. Over the next few pages, our engineers give you all the information necessary to make the optimum choice of bearings and how to install them correctly.*

• Preloading, definition of symbols	12-14
• Rigidity, axial deflection	15
• Influence of an external axial load	16
• Speed correction factor	17
• Spindle design	18-24
• Lubrication	25-27
• Selection guide	28-29
• Ceramic ball bearings (CH)	30-31
• High speed bearings (ML)	32
• Sealed bearings (MLE)	33
• HNS bearings (N)	34
• Assembly demonstration	35-36

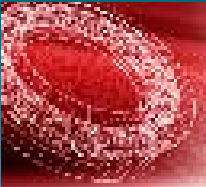

# Preload: a direct effect on the application

## Preload and preloading

Preload is an important characteristic for any assembly as it is used to achieve a defined, managed rigidity. It also has a direct influence on the load capacity and allowable rotational speed.

Preloading an assembly consists of applying a permanent axial load by abutting the faces of the bearings in the assembly. This load will lead to an elastic deformation between balls and raceway and will create a contact pressure between the components.

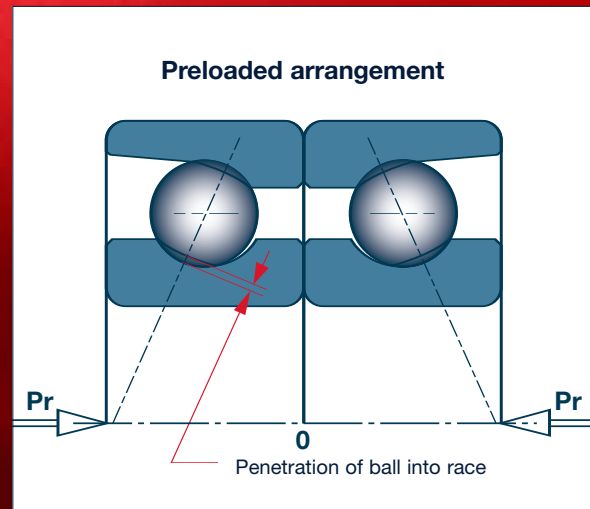
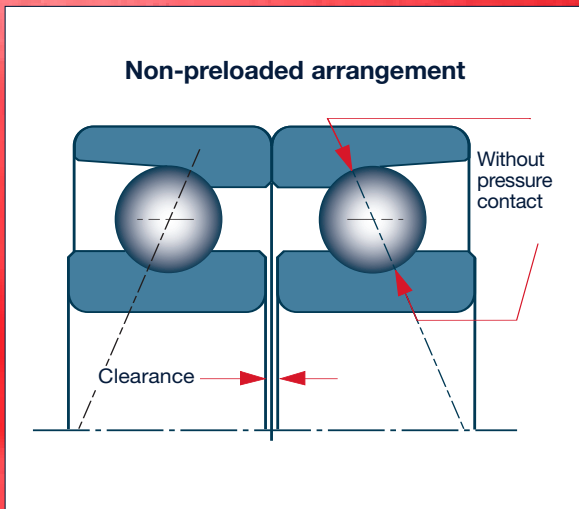

**Example: assembly 7014HVDBJ84**

**Clearance:** 0,012 mm

**Preload:**  $Pr = 1100$  N

**Deflection:** 0,0025 mm

**Contact pressure:**

- inner ring: 960 N/mm<sup>2</sup>

- outer ring: 840 N/mm<sup>2</sup>

*The axial load is known as preload ( $Pr$ ).*

## Two methods for application

### Preloading by tightening faces of bearings in an assembly

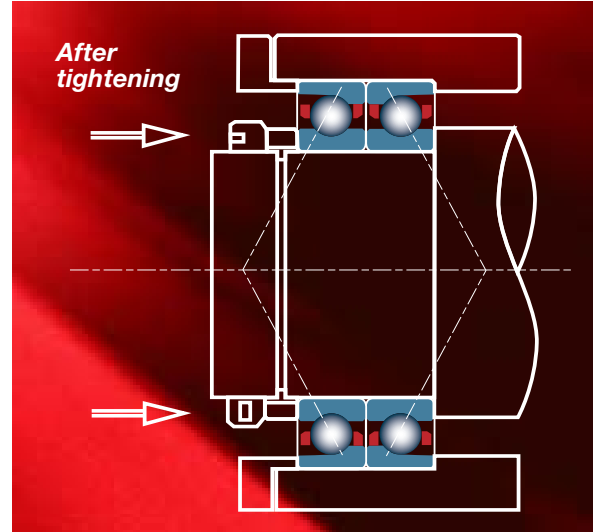
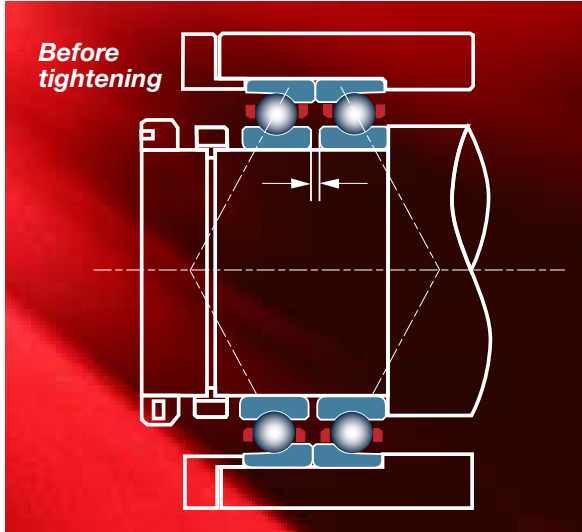

### Preloading using calibrated springs

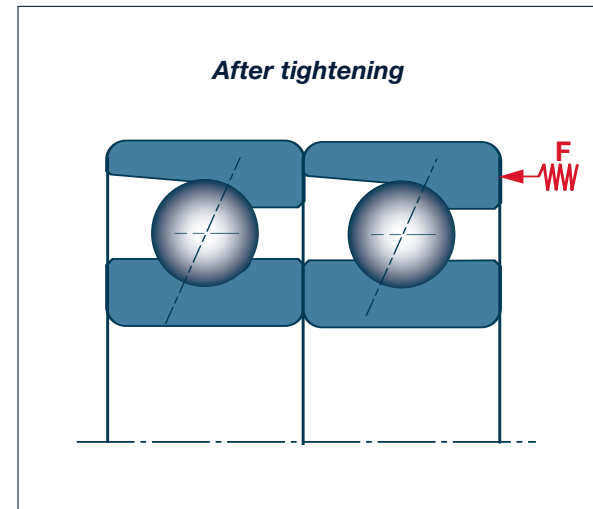
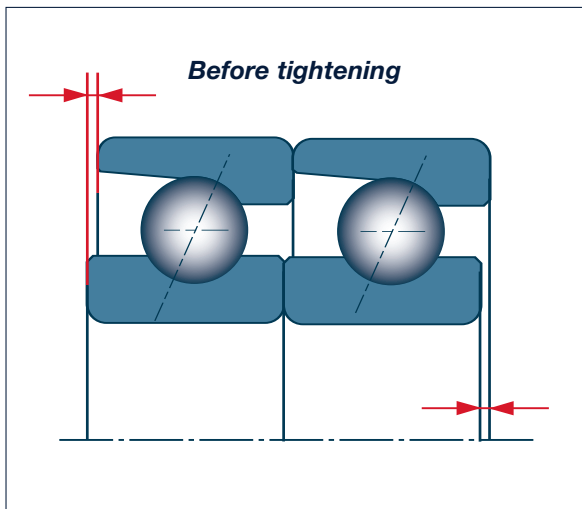

## Definition of symbols

$P_r$	Preload	$P$	Equivalent dynamic load
$a$	Distance between the 2 spacers ( $\mu\text{m}$ )	$C$	Basic dynamic load
$K$	Deflection constant ( $\mu\text{m} (\text{daN})^{-2/3}$ )	$P_0$	Equivalent static load
$P_{r_i}$	Initial preload (daN)	$C_0$	Basic static load
$P_{r_s}$	Preload required (daN)	$N$	Rotation speed (rpm)
$P_E$	Equilibrium preload for an assembly	$L_{10}$	Nominal service life (hr)
$C_D$	Separation load	$f_s$	Safety factor
$F_a$	Axial load	$L_{na}$	Corrected service life (hr)
$F_r$	Radial load	$N.Dm$	Speed factor

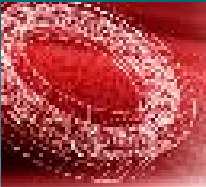

# Preload: parameters to take into account

## Preload levels

SNR has defined 3 preload levels which correspond to a level of contact pressure suitable for operating conditions:

- **Light preload (code 7):**  
High-speed, light load applications.
- **Medium preload (code 8):**  
Best balance between speed and load.
- **Heavy preload (code 9):**  
Large load, reduced speed applications.
- SNR can supply specific **preloads on request (code X)** to meet spindle operation optimization requirements.

Should a specific preload be required, it can be achieved using bearings preloaded as standard assembled with different length spacers.

The following formula is used to calculate the space required between two spacers to alter the bearing assembly preload:

$$a = 2K(Pr_i^{2/3} - Pr_s^{2/3})$$

a: difference in length between the 2 spacers (µm)

K: deflection constant (see page 44)

Pr<sub>i</sub>: initial preload (daN)

Pr<sub>s</sub>: preload required (daN)

*See also page 15, axial deflection of an angular contact ball bearing.*

## Factors influencing preload

The following factors can influence the preload value:

- **assembly interference** (fits),
- **rotation speed**,
- **temperature**, possibly associated with shaft and housing materials,
- **geometry of the surrounding parts.**

Make sure these parameters are fully taken into account when a spindle is designed. Contact SNR's design office for any further information. They are always prepared to share their expertise in this area.

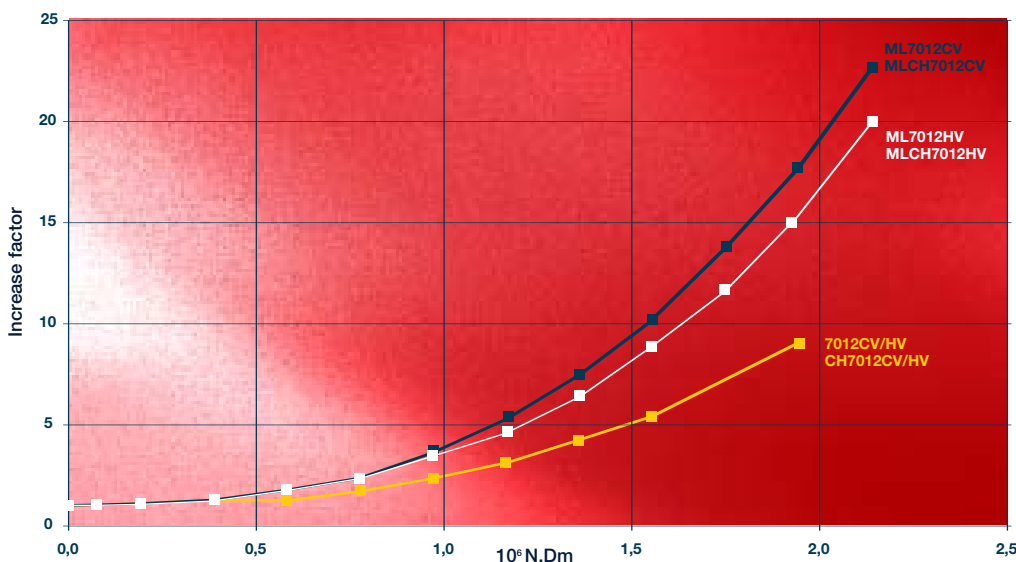

**Preload increase factor according to rotation speed: comparison between 7012 and ML7012 bearings, versions with steel or ceramic balls.**





# Rigidity and axial deflection

## Rigidity as a function of preload

Example: a 7012 bearing assembled in DB

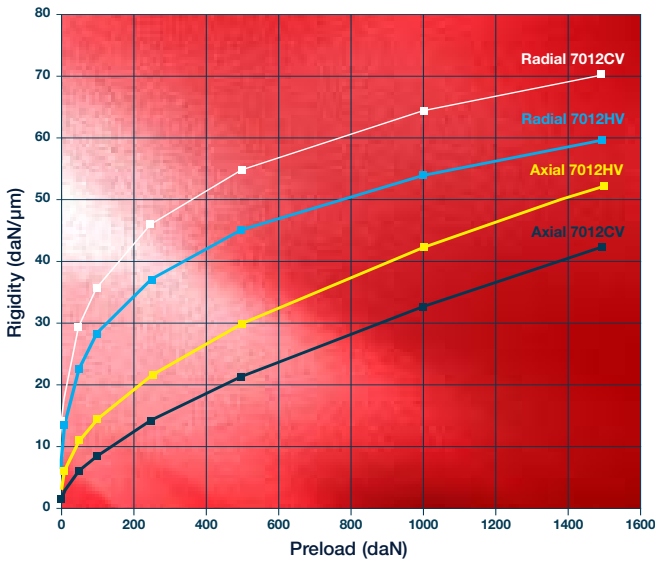

Comparison of rigidity by series

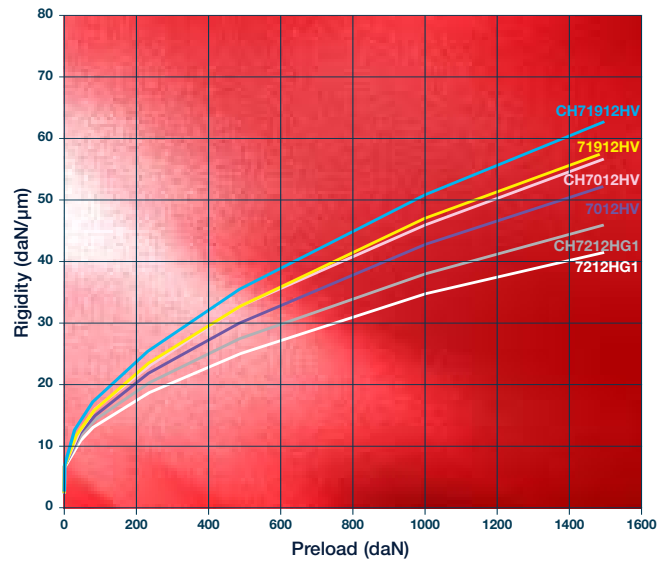

The rigidity is given by the preload. As preload increases, rigidity also increases in a non-linear manner.

## Axial deflection of an angular contact ball bearing

When a bearing is subject to an axial load  $F_a$  in daN, one of the rings undergoes axial displacement with respect to the other, with a value  $\delta a$ :  $\delta a = K(F_a)^{2/3}$

$K$  is the axial deflection constant for each bearing and its value is given in the preload table (see page 44).

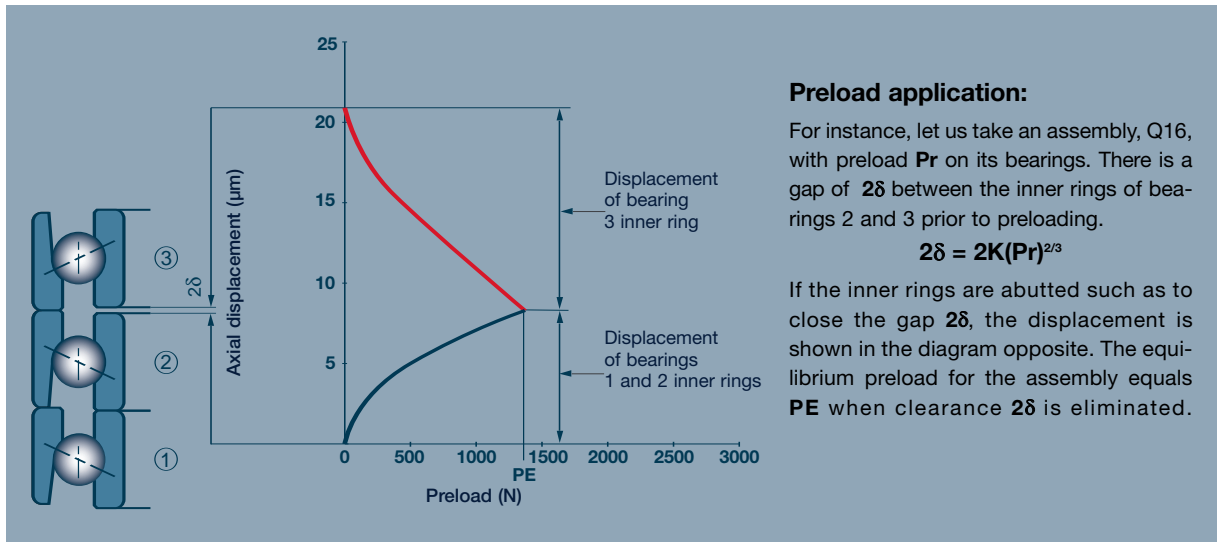

# Influence of an external axial load

## Axial deflection graph for assembly Q16

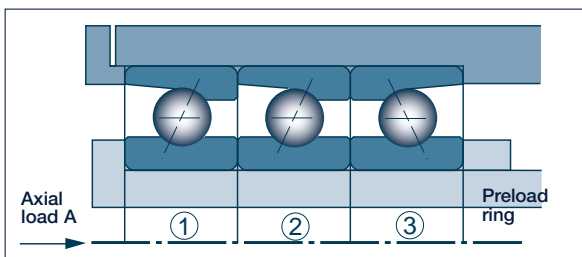
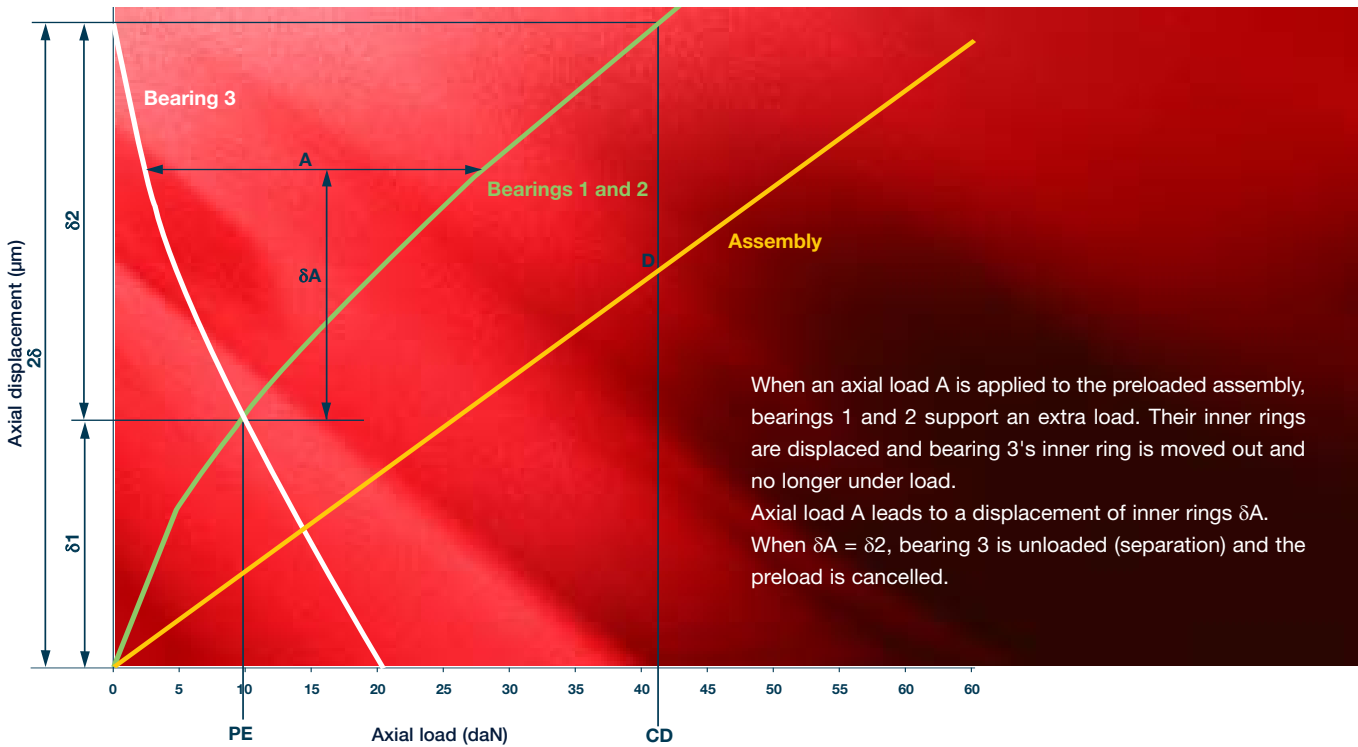

### Characteristic values for equilibrium preload PE and detachment load CD

### Characteristics

- **Axial displacement:** until preload is cancelled, this is equal to  $\delta 2$ . With the initial approximation, it is defined by the line OD. Beyond point D, the curve represents the bearings supporting axial load  $A$ : in the above examples, bearings 1 and 2.
- **Axial rigidity:** until the preload is cancelled, mean rigidity is equal to  $CD/\delta 2$ .
- **Detachment load CD:** this is the axial load that leads to the separation of the bearing(s) in opposition: in the above example, bearing 3.

Assembly	PE	CD
DB - DF	Pr	2.83 Pr
<b>Q16</b>	1.36 Pr	5.66 Pr
<b>Q21</b>	2 Pr	5.66 Pr

Pr: preload

*Our engineers can send you the characteristic curves for any assembly on request. The axial and radial rigidity values for preloaded bearings are given on page 44.*

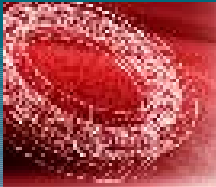

# Speed correction factors

Each bearing can only rotate up to a certain speed known as its limit speed. A bearing's limit speed depends on its design, lubrication method and the thermal level tolerated at this speed. If any of these parameters are altered, the limit speed is altered.

## According to assembly

When bearings are put together in an assembly, the limit speed of the single bearing must be adjusted according to the assembly and the preload.

*The limit speed for a single bearing is defined on page 41. For MachLine hybrid bearings, this value should be increased by 30 % (see page 31).*

## According to preload

Preload is selected from three suggested levels: *light, medium and heavy*. The level should be selected according to the spindle's maximum speed, the desired rigidity and the detachment load.

## Speed correction\*

After the above selections have been made, it is important to ensure that they can reach the required maximum spindle speed.

\* This factor is given for information to help in design. If a spindle is to be used continuously close to its limit speed, the thermal level reached should be checked to ensure that it is compatible with the required precision.

For other types of assembly, please contact SNR.

Assembly	Preload		
	Light	Medium	Heavy
DT	0.90	0.80	0.65
DB	0.80	0.70	0.55
DF	0.75	0.65	0.40
Q16	0.70	0.60	0.35
Q21	0.65	0.55	0.30

*Any non-compliance with the requisite geometric tolerances detracts from the assembly's maximum speed and thus from correct spindle operation.*



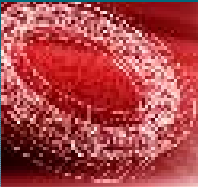

# Spindle design: simplified calculation method

## | Bearing pre-design

This must be checked and optimized either by using the simplified and/or corrected calculation method with the bearing service life method, or by using an application-specific software design package.

---

## | Required service life

The bearing service life on a spindle is linked to the loss of machining precision (dimensional precision, vibrations) or to abnormal heating.

This loss of precision is due to deterioration of race-way surfaces and balls due to wear, contamination, oxidation or lubricant deterioration (oil or grease).

The corresponding service life cannot be directly calculated. The only possible calculation is for service life  $L_{10}$  linked to material fatigue. Experience has shown that to give suitable spindle dimensions, service life  $L_{10}$  should be of the order of 20,000 hours.

---

## | Simplified calculation method

This most simple method, recommended by the **ISO 281 standard** is used to calculate the nominal service life reached by 90 % of bearings working under a dynamic load.

**The simplified calculation method shown opposite is based on material fatigue as cause of failure.**

## | Equivalent dynamic load

The torque and drive loads must be distributed over each bearing by using the normal methods of mechanical engineering.

- **Axial load:** This is to be distributed uniformly over each bearing supporting this load. If “m” bearings support this load:

$$F_a = A / m$$

A = axial load applied to main bearing.

- **Calculating the equivalent dynamic load:**

$$P = X Fr + Y Fa$$

Coefficients **X** and **Y** are described in the table opposite. To define them, calculate the ratio **Fa/Co** and read the value for **e** and calculate **Fa/Fr** and compare it to **e**.

**Co** is the basic static radial load.

If the load varies between different machining types, the weighted equivalent radial load calculated is as follows:

$$P = (t_1 P_1^3 + t_2 P_2^3 + \dots + t_i P_i^3)^{1/3}$$

$t_i$  = usage rate

$P_i$  = corresponding equivalent load

- **Radial load:** This is to be distributed uniformly to each bearing making up the main bearing. If there are « n » bearings making up the main bearing, the radial load applied to each bearing will be:

$$Fr = R / n^{0,9}$$

R: radial load applied to main bearing

	Fa/Co	e	Fa/Fr ≤ e		Fa/Fr > e	
			X	Y	X	Y
15°	0.015	0.38	1	0	0.44	1.47
	0.029	0.40	1	0	0.44	1.40
	0.058	0.43	1	0	0.44	1.30
	0.087	0.46	1	0	0.44	1.23
	0.12	0.47	1	0	0.44	1.19
	0.17	0.50	1	0	0.44	1.12
	0.29	0.55	1	0	0.44	1.02
	0.44	0.56	1	0	0.44	1.00
	0.58	0.56	1	0	0.44	1.00
	25°	-	0.68	1	0	0.41

## | Nominal service life

$$\text{Life in hours: } L_{10} = (C/P)^3 \cdot 10^6 / 60N$$

C: dynamic basic load (see page 41)

Co: basic static radial load (see page 41)

N: rotation speed of the rotating ring in rpm

*The life of the bearings on the spindle is calculated to be the service life of the bearing supporting the greatest load.*

machline®



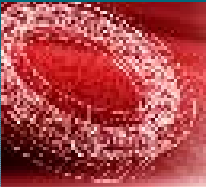

# Spindle design: simplified and corrected calculation method

## | Equivalent static load

Should a bearing be subject to combined static loads, the equivalent static load needs to be calculated to compare it with the bearing's static load capacity.

### - Calculating the equivalent static load:

$$P_o = X_o F_r + Y_o F_a$$

Coefficients  $X_o$  and  $Y_o$  are given in the table opposite. To define them, the ratio  $F_a/F_r$ .

*A bearing's static load capacity is given as a reference value rather than an accurate limit that should not be exceeded. It is useful to take it into account, for instance, in assessing the influence of punctual loads such as those generated by tool release or bar advance systems.*

	$F_a/F_r$	$X_o$	$Y_o$
15°	$\leq 1.09$	1	0
	$> 1.09$	0.50	0.46
25°	$\leq 1.31$	1	0
	$> 1.31$	0.50	0.38

- **Basic static capacity for a bearing  $C_o$ :** This is defined in **ISO 76 standard** as the radial load that generates a Hertz pressure of 4,200 MPa at the most highly loaded point of contact (rotating body and raceway).

$$\text{Safety factor: } f_s = i C_o / P_o$$

$i$ : Number of bearings  
 $C_o$ : Basic static load of bearing  
 $P_o$ : Equivalent static load

In principle, the minimum values for the safety factor  $f_s$ :

- 2.5 to 3 for spindles in general
- 1 to 1.5 for a short-term axial load.

## | Corrected calculation method

The **ISO 281 standard** gives a corrected nominal service life formula  $L_{na}$  which is expressed as a function of the basic nominal service life  $L_{10}$ :  $L_{na} = a_1 \cdot a_2 \cdot a_3 \cdot L_{10}$

### - Coefficient $a_1$

Coefficient used to correct a calculation for a reliability value other than 90 %. This factor is given in the table below:

Life	Reliability	Probability of failure	$a_1$
$L_{10}$	90%	10	1.00
$L_5$	95%	5	0.62
$L_4$	96%	4	0.53
$L_3$	97%	3	0.44
$L_2$	98%	2	0.33
$L_1$	99%	1	0.21

### - Coefficient $a_2$

Coefficient for correcting calculation according to material and internal geometry.

*For certain applications, a bearing may be manufactured from a special steel other than conventional steel, or have a non-standard internal geometry. These selections can give a much greater service life than that of a standard bearing.*

*In this case, a coefficient  $a_2$  which is greater than 1 is applied. This coefficient is calculated according to experimental results obtained in SNR's research and testing centers.*

Material	$a_2$
100Cr6	1
XD15N	2.8

**- Coefficient  $a_3$**

Coefficient for correcting calculations according to operating conditions: contamination, lubrication, temperature... **Please note that coefficients  $a_2$  and  $a_3$  are not independent.**

**- Coefficient  $a_{3pol}$**

Contamination can reduce service life, depending on its type and the level at which the rotating parts are loaded.

**In most cases,** a spindle bearing operates in maximum cleanliness conditions, **and coefficient  $a_{3pol}$  will thus equal 1.**

**For other types of applications** which are less well protected, coefficient  $a_{3pol}$  can have the following values:

Filtration	$a_{3pol}$
< 3 $\mu\text{m}$	1
5 $\mu\text{m}$	0.95
10 $\mu\text{m}$	0.90

**- Coefficient  $a_{3lub}$**

Bearing service life is influenced by the efficiency of lubrication, which, amongst other things, is characterized by the oil film thickness. Elasto-hydrodynamic theory shows that this latter value depends almost entirely on oil viscosity and speed. The graphs below can be used to determine coefficient  $a_{3lub}$ .

**Graph 1: viscosity-temperature**

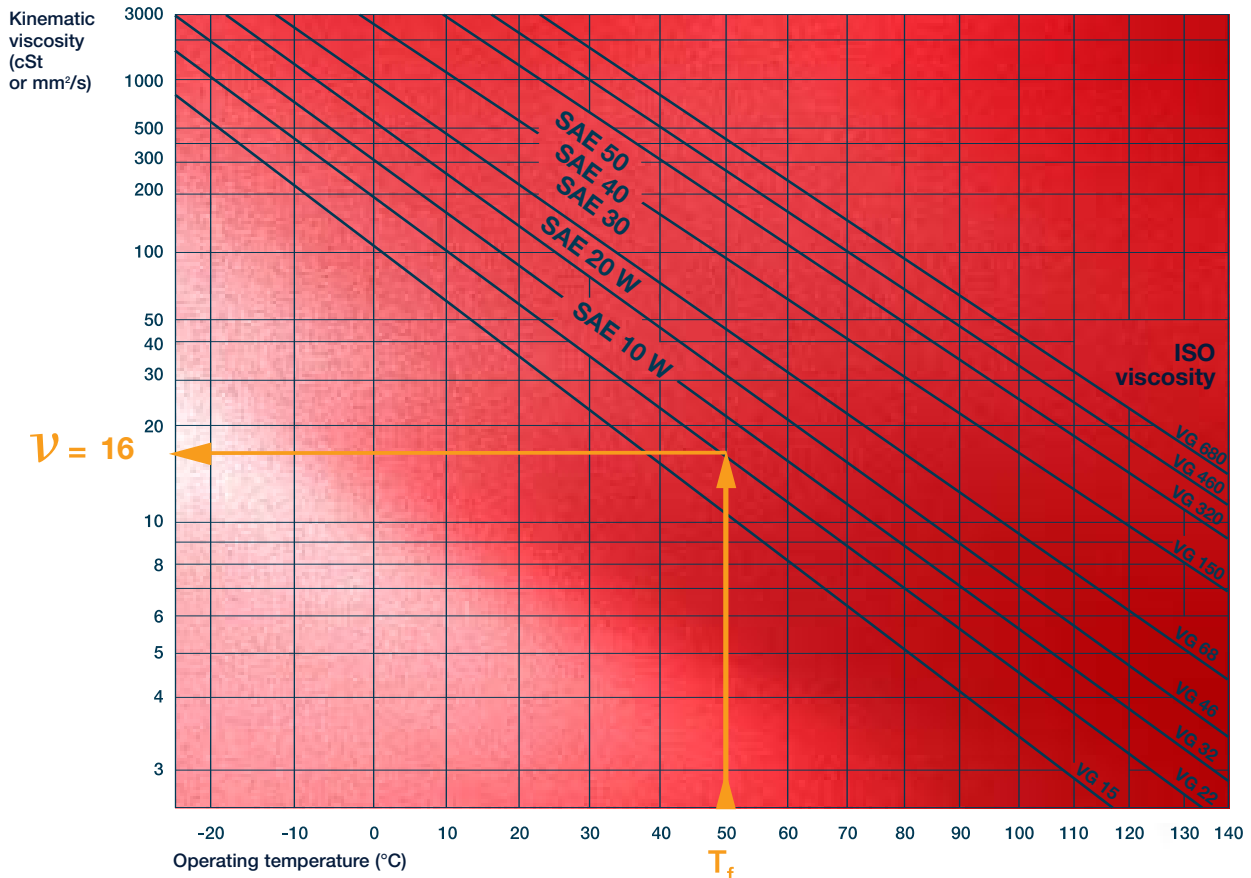

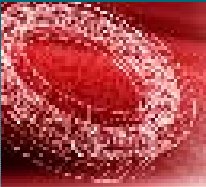

# Spindle design: corrected calculation method

Graph 2: required viscosity

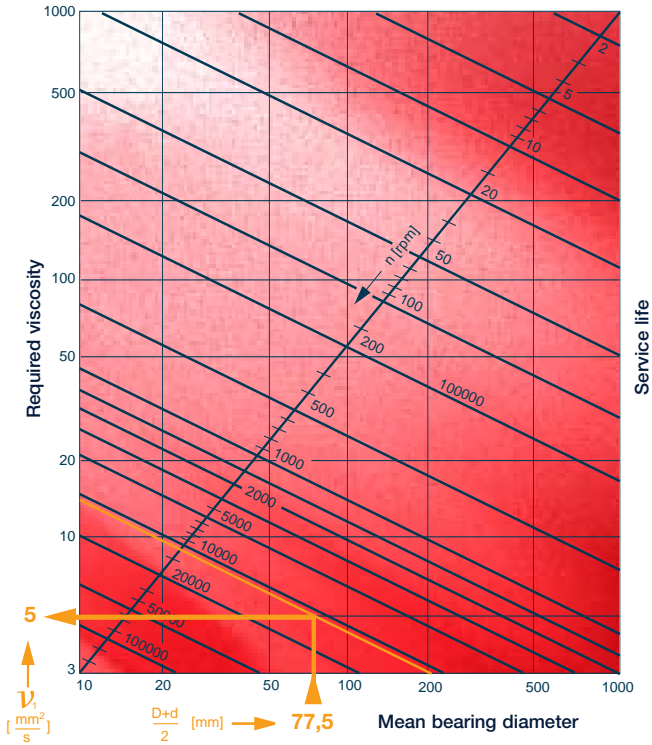

## Example

Bearing 7012CV at 13,000 rpm lubricated with VG22 oil and operating at 50°C.

Graph 1: VG22 oil viscosity at 50°C is  $\nu = 16$  cSt

Graph 2: required viscosity for a 7012CV with mean diameter  $D_m = 77.5$  mm at 13,000 rpm is:  $\nu_1 = 5$  cSt

Graph 3: coefficient  $a_{3lub}$  with viscosity ratio  $\nu/\nu_1 = 16/5 = 3.2$  is  $a_{3lub} = 2.5$

Graph 3: coefficient  $a_{3lub}$

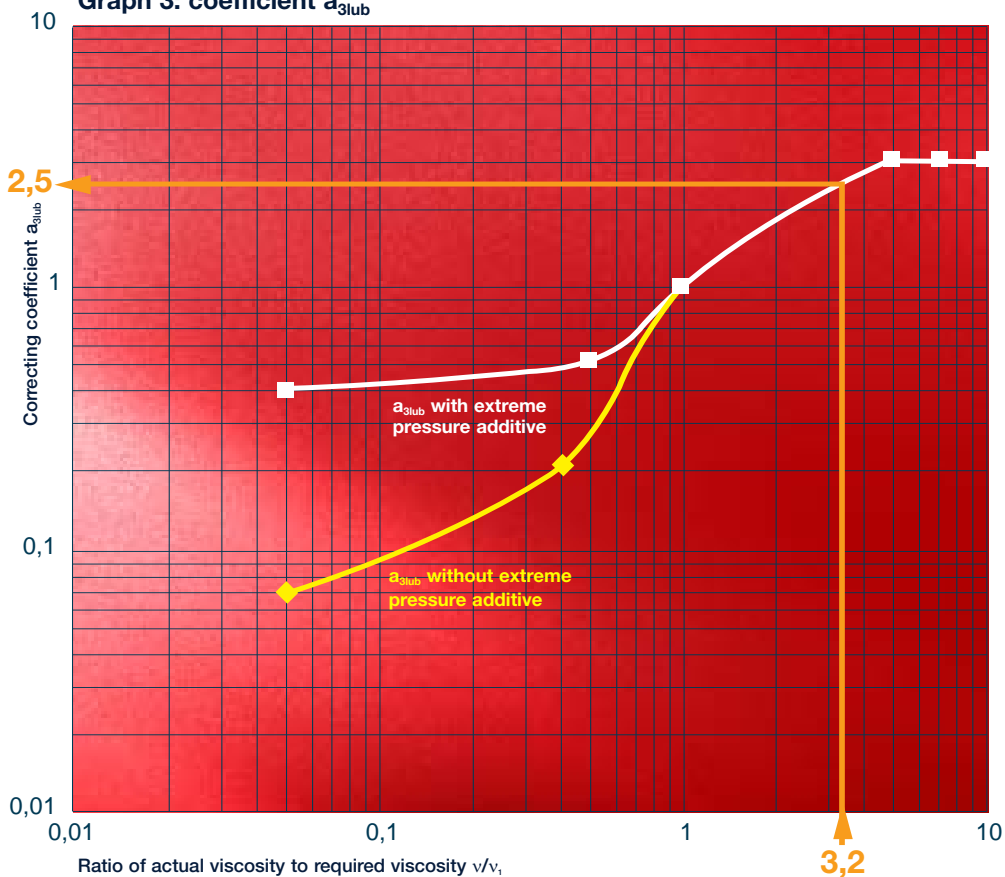



**- Coefficient  $a_{3temp}$**

The operating temperature for bearing components is given in the table below:

Component	Max. temp.	Comment
Rings	150°C	-
<b>Balls</b>		
- steel	150°C	-
- ceramic	> 200°C	-
<b>Cage</b>		
- phenolic resin	100°C continuous 120°C peak temperature	Standard
- bronze	200°C	On request
- PEEK	120°C en continu 150°C peak temperature	On request
<b>Seals</b>	100°C continuous 120°C peak temperature	- -
<b>Grease</b>	120°C	-

**For most machine tool spindle applications,** coefficient  $a_{3temp} = 1$  is used, as the operating temperature is well below 100°C.

**For other, more exposed applications,** coefficient  $a_{3temp}$  can have the following values:

Temperature	$a_{3temp}$
< 100°C	1
110°C	0.96
120°C	0.92
130°C	0.88
140°C	0.84
150°C	0.8

## | Infinite service life

In the area of materials development, we can define conditions under which bearings can have an infinite service life:

- Metal surfaces fully separated by a film of oil, giving  $a_{3lub} > 1.5$ .
- Extremely limited oil film contamination, giving  $a_{3pol} = 1$ .
- Load applied corresponds to  $Co/Po > 9$ , corresponding to Hertz pressure values lower than: 2,000 MPa for 100Cr6, 2,300 MPa for XD15N.



# Spindle design: simulations

## Design software

SNR's R&D department has developed design software for use in optimizing and checking spindle bearing dimensions. This software gives a fuller and more accurate simulation than the simplified or corrected methods. It provides a means to model the spindle and its bearings and to properly take load, rotation speed and lubrication into account. The software simulates the equilibrium state of a spindle rotating on bearings and subject to external loads.

- **It determines:**
  - **loads and the deflection** at the contact between balls and rings,
  - **loads applied** to each bearing,
  - **displacement of inner and outer rings,**
  - **shaft deformation,**
  - **axial and radial rigidity** at the selected reference point.
- **It calculates:**
  - **the pressure values and dimensions of the elliptical contact surfaces,**
  - **the service life  $L_{10}$**  of the bearings, based on the contact capacity,
  - **the thickness of the lubricant film** (the service life is adjusted in the event of insufficient film thickness).

## Graphic display of input data and SNR results

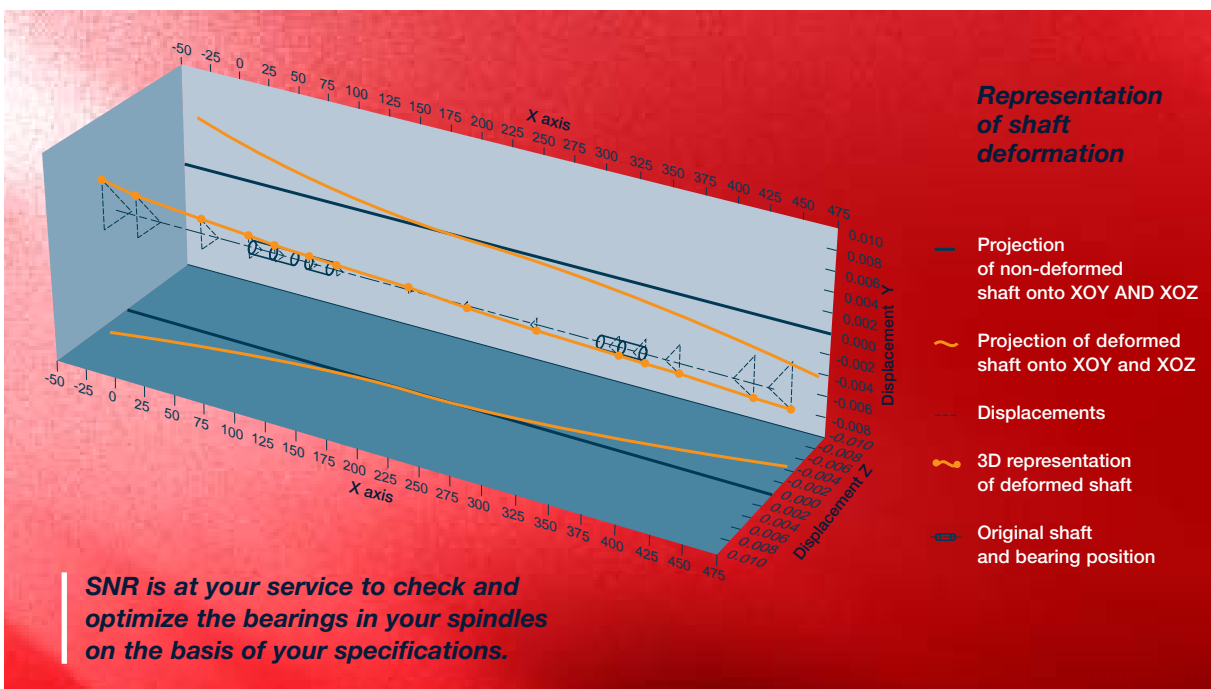
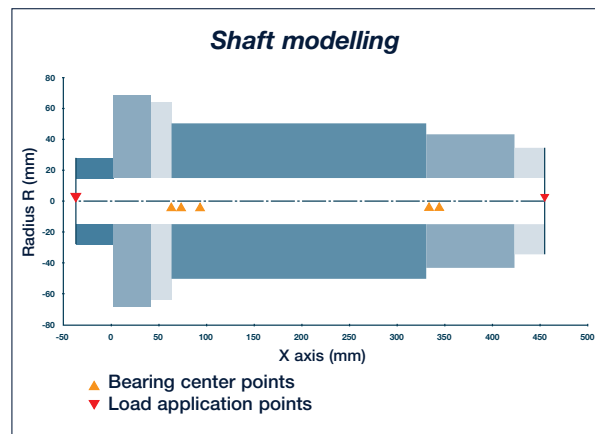



# Appropriate lubrication: the secret for long bearing life

*Lubrication is an essential component of correct bearing function. It is used to avoid wear and seizure by placing an oil film between the rotating parts and the raceway. It also cools the bearing, by removing dissipated heat from the contacts and provides long-term corrosion protection for the bearing.*

## | Selection of lubrication method

This is determined according to the maximum rotation speed and the loads, which determine the quantity of heat to be removed. It is thus inextricably linked to machine design.

- **Grease lubrication** is recommended when the maximum required speed allows and when

the heat produced can be removed by conduction via the environment without leading to overheating ( $\Delta T$  generally permitted 20 to 25°C).

- **Oil lubrication** (using oil mist or oil-air) is recommended in other situations.

## | Oil lubrication

When the rotation speed exceeds the limit speed for grease lubrication, oil lubrication must be chosen. SNR recommends that a low-viscosity oil is selected in order to minimize heating effects - viscosity of the order of 20 cSt at 40 °C (unless loads applied are very high).

- **Oil mist lubrication:** lubrication occurs by means of a gentle flow of oil sprayed into an air duct. Circulation of filtered dry air is used for cooling.

For instance, for a 7016 bearing, the oil flow would be 50 mm<sup>3</sup>/hr per bearing, and the air pressure 0.7 to 2 bar. Excess pressure generated in the spindle improves sealing.

- **Oil-air lubrication:** oil droplets are periodically introduced into an air duct. This system is cleaner and provides a good replacement for the oil mist system. Lubricant quantity can be better managed in this way.

## | Settings for 7016 bearing (example):

- **Oil flow:** 60 mm<sup>3</sup>/hr for each bearing
- **Injection frequency:** 8 min.
- **Air pressure:** 1.0 to 2.5 bars.

- **Note:** settings are given for information and must be optimized to achieve the lowest possible thermal level.

- **Circulation channels:** the lubricant must be directed as close as possible to the bearing and introduced between the inner ring and the cage.

*The oil inlet pitch diameter (D5) and the space between inner ring and cage (E) are defined on page 40.*

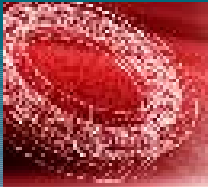

# Appropriate lubrication: the secret for long bearing life

## Grease lubrication

SNR recommends its own SNR-LUB GV+ grease. It provides good resistance to high speeds and loads and enables a low operating torque value.

### SNR-LUB GV+:

- **Base:** synthetic oil, lithium soap.
- **Additives:** antioxidant, anti-wear, anti-corrosion, extreme pressure.
- **Low viscosity:** : 15 cSt at 40°C
- **Operating temperature:** between -50°C and +120°C.

**LUB GV+ grease is particularly recommended for applications with vertical shafts.**

*The volume of grease recommended by SNR is defined in the table opposite. Alter this volume according to the operating speed on the basis of the correcting coefficients below.*

% limit speed	Correcting coefficient
< 35 %	1
35 % à 75 %	0,75
> 75 %	0,60

### MachLine high speed range - ML

Mean volume of grease per bearing in cm<sup>3</sup> - tolerance ± 10%

Bore code	Series 70	Series 719
00	0.1	0.1
01	0.2	0.1
02	0.3	0.1
03	0.3	0.1
04	0.6	0.3
05	0.8	0.4
06	1.0	0.5
07	1.4	0.6
08	1.7	1.0
09	2.2	1.1
10	2.4	1.1
11	4.4	2.3
12	4.6	2.6
13	5.2	2.7
14	6.7	4.3
15	7.1	4.6
16	9.3	4.8
17	9.6	6.5
18	12.9	6.8
19	12.8	7.0
20	13.5	9.6
21	18.3	-
22	22.1	10.3
24	23.5	13.3
26	34.8	17.5

### MachLine high precision range

Mean volume of grease per bearing in cm<sup>3</sup> - tolerance ± 10%

Bore code	Series 70	Series 72	Series 719
00	0,3	0,4	0,2
01	0,4	0,5	0,2
02	0,5	0,6	0,3
03	0,6	0,8	0,3
04	1,0	1,3	0,5
05	1,2	1,7	0,6
06	1,6	2,3	0,7
07	2,0	3,3	1,0
08	2,5	3,5	1,5
09	3,2	5,3	1,6
10	3,4	6,2	1,7
11	4,7	7,5	2,2
12	5,0	9,2	2,3
13	5,3	11	2,5
14	7,5	13	4,2
15	7,8	14	4,3
16	10	16	4,5
17	11	21	6,3
18	14	26	6,5
19	15	-	7,3
20	16	38	9,7
21	19	-	10
22	24	52	10
24	25	63	14
26	40	-	19
28	42	-	20
30	51	-	30
32	64	-	31
34	83	-	32
36	107	-	50
38	110	-	52
40	140	-	74
44	190	-	80
48	-	-	86

Example: 7016 bearing to be used at 7,000 rpm (64 % of its limit speed with grease).  
Grease volume to be used:  
10 cm<sup>3</sup> x 0.75 = 7.5 cm<sup>3</sup>  
N.Dm = product of mean bearing diameter (mm) multiplied by rotation speed (rpm).  
Grease application: see page 64.

## Regreasing

- **Basic regreasing frequency:** the graph below can be used to determine the basic frequency in hours according to bearing type.

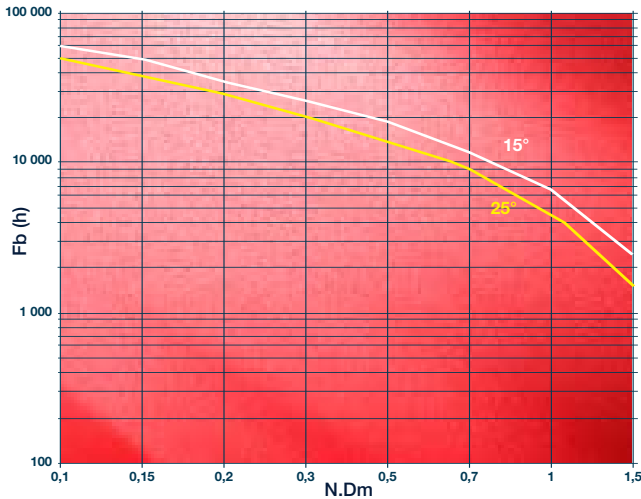

*These values are given for information and must always be confirmed by testing.*

- **Correcting regreasing frequency:** the basic frequency  $F_b$  must be corrected by coefficients given in the table below, according to particular spindle operating conditions, using the equation:  
 **$F_c = F_b \cdot T_e \cdot T_a \cdot T_t$**

Coef.	Conditions	Level	Coef. value
<b>T<sub>e</sub></b>	<b>Environment</b>		
	- dust	Low	1
	- damp	Medium	0.8
	- condensation	High	0.5
<b>T<sub>a</sub></b>	<b>Application</b>		
	- vertical shaft	Low	1
	- vibrations	Medium	0.8
	- impacts	High	0.5
<b>T<sub>t</sub></b>	<b>Temperatures</b>		
	< 75°C		1
	75° to 85°C		0.8
	85° to 120°C		0.5

## Grease life

Often spindle bearings are assembled such that the Hertz pressure values enable almost infinite resistance to fatigue. For this type of application, the grease life becomes an important factor in defining bearing service life.

Grease life is the period during which the grease will maintain its initial characteristics and lubricating power. For any given grease, it is mainly a function of the bearing rotation speed and its operating temperature.

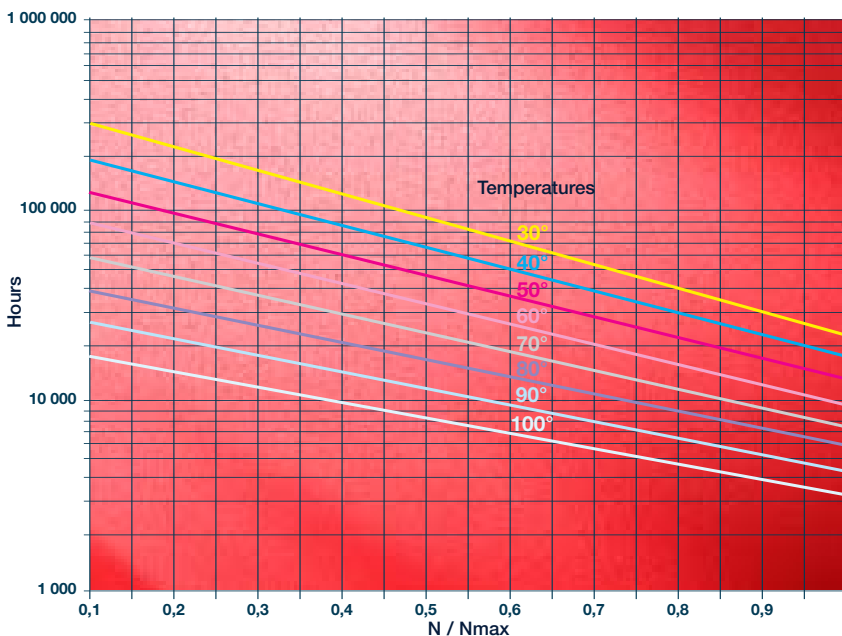

*N: bearing rotation speed  
 N<sub>max</sub>: bearing rotation limit speed  
 T: operating temperature (°C)*

*These values are given for information and must always be confirmed by testing.*



# MachLine® selection guide

**Our MachLine range has been designed for spindle applications for most machine tools: lathes, milling and drilling machines, center bores, grinders, high speed spindles, etc. Their capacity to support operating constraints - cutting and drive forces - and their high rotation speeds have been optimized for the following criteria: rotational accuracy, dimensional stability, geometrical micro and micro variations, rigidity, heat, vibration and service life.**

## Features of angular contact bearings

- Very high quality 100Cr6 steel rings and balls,
- Two contact angles: 15° and 25° (17° and 25° for MachLine ML and MLE range),
- Laminated resin cage centered on outer ring (Bronze or PEEK cage on request),
- Three preload grades (specific preloading on request),
- Standard precision P4S: ISO4 (ABEC 7) for dimensional characteristics and ISO2 (ABEC 9) for all dynamic characteristics. It is also possible to supply products with ISO 2 precision.

**With our manufacturing know-how we can align the preloaded outer ring and inner ring with very high precision, guaranteeing offset of less than 2µm. This non-standardized characteristic determines the preload value, which has a significant influence on spindle rigidity and behavior.**

## Comparison of internal geometry

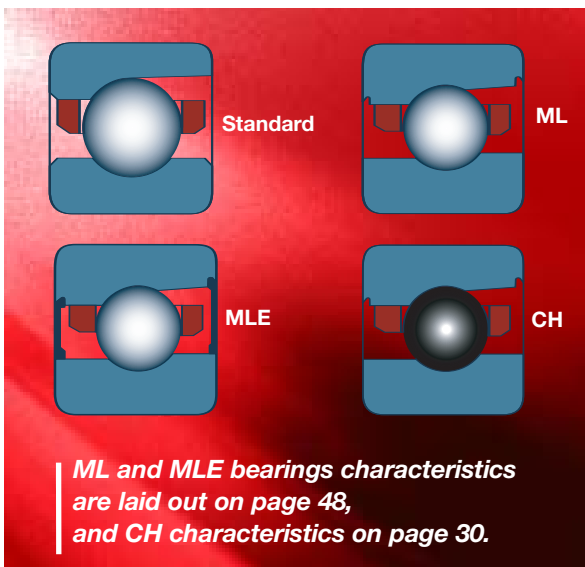

- **MachLine High Speed – ML:** Speeds 30 % faster than the standard range are achieved using an increased number of balls with reduced diameter and improved cage guidance on the outer ring.
- **MachLine Sealed – MLE:** Performance values at speeds comparable to a standard bearing lubricated with oil are achieved with grease lubrication by using non-contact seals on ML range bearings.
- **MachLine Hybrid – CH:** Bearing performance can be further enhanced by using ceramic balls instead of steel balls.

## Dimensions by series

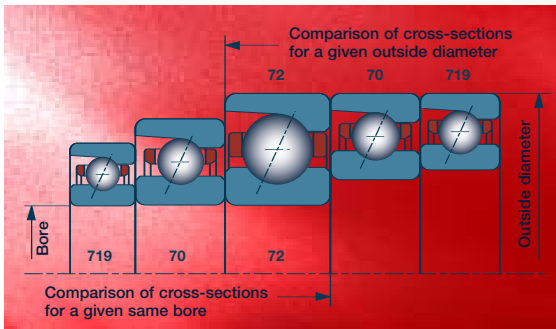

## Bearing series and version codes

Series	Version code
7000	V
71900	V
7200	G1

- **V version:** Series 71900 and 7000 are the best suited to high rotation speeds. They provide the best combination of speed, capacity, rigidity and precision characteristics.

- **G1 version:** The G1 version was specially designed to meet series 7200 specifications, which is designed to withstand predominantly major axial loads.

### Version selection:

**SNR offers several options for creating a bearing arrangement.**

## Features of versions on offer

- **UNIVERSAL bearing, code U:** with the selected preload, the inner ring and outer ring surfaces of these bearings are on the same plane. All types of arrangements can be achieved with this bearing.

- **Arrangements of UNIVERSAL bearings, codes DU, TU, QU...:** Arrangement of several universal bearings whose outside diameters and bores are selected to ensure a tolerance range no more than half the ISO tolerance level.

- **Arrangements of MATCHED bearings, codes DB, DF, DT, Q16, Q21...:** These assemblies are matched by SNR and must not be re-arranged. They have the following characteristics:

- Matching preload values,
- Variation of outside diameter and bore values within a tolerance range no more than half the ISO standard tolerance,
- Assembly is identified with a "V" marked on the outside diameter of all bearings in an assembly.

**These features, in particular the extremely precise preload values, mean that greater spindle precision can be achieved, with better rigidity and longer life.**

### Examples of identification codes for matched assemblies

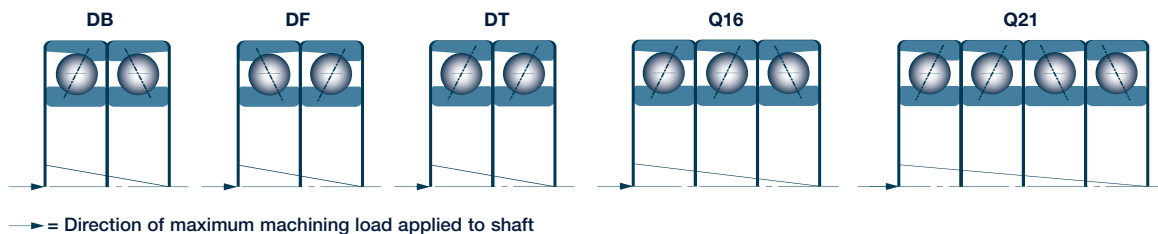

## Specific tolerances

Certain specific applications may require bearings with lower bore and outside diameter tolerances, values centered with respect to ISO 4 tolerance

specifications. These bearings are identified with the letter R, as shown in the following coding example: 71912CVURJ74.



## MachLine® CH - Hybrid: selecting a ceramic ball

*The internal design of SNR series can greatly increase bearing performance and life with ceramic balls.*

### | Ceramic properties

The ceramic used is a Silicone Nitride:  $\text{Si}_3\text{N}_4$

- low density:  $3.2 \text{ kg/dm}^3$ ,
- low coefficient of thermal expansion,
- high modulus of elasticity:  $310.000 \text{ N/mm}^2$ ,
- non-magnetic,
- low coefficient to friction,
- electrical insulator,
- low heat conductivity,
- corrosion-resistant.

### | Significant results

These physical properties make it possible to:

- **increase rotation speed at a given operating temperature,**
- **improve bearing rigidity,**
- **increase bearing life.**

*All MachLine High Precision ranges, ML, MLE and 7000, 71900 and 7200 series are available as a hybrid version.*





## Performance values for MachLine CH - Hybrid

**↑ Increase in rotation speed:**  
**+ 30%**

The kinematics of SNR hybrid bearings generates less slipping and heating than steel ball bearings. At a given temperature, they can operate at approximately 30 % higher speeds than steel ball bearings.

**↑ Improved rigidity:**  
**+ 10%**

The fact that the modulus of elasticity of ceramics is higher than that of steel means that the rigidity of a hybrid bearing can be increased by approximately 10 % under a given preload.

*In certain situations, the properties of "hybrid" bearings may allow grease lubrication where air-oil lubrication would otherwise be required due to the required rotation speed. This option provides economic advantages.*

**↑ 3 times longer life:**  
**x 3**

The lubrication and friction behavior of ceramics, in particular, their low friction coefficient and capacity to operate in reduced lubrication conditions, means that bearing raceways resist wear and damage much longer than with steel balls. The actual service life depends on operating conditions, but has been observed to be on the order of 2 or 3 times greater than steel ball bearings (under comparable operating conditions).

**↓ Lubrication:**  
**Reduce costs**

Lubricants used for 100Cr6 steel bearings can generally be used with ceramic ball bearings. Some applications may require a specific study to define the recommended lubricant.

### Example for a CH7009CVDTJ04, spring preloaded to 550 N

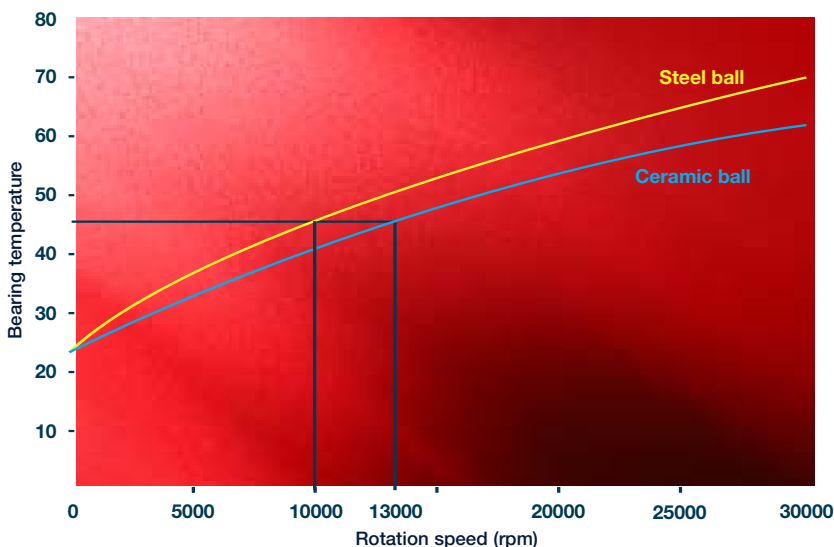

Temperature as a function of rotation speed:  
At a temperature of 45°C, the rotation speed goes from 10,000 rpm with steel balls to 13,000 rpm with ceramic balls.

machline



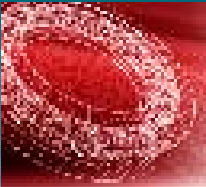

# MachLine® ML - High Speed: our solution for very high speeds

*SNR has developed a range specifically designed to meet increasingly stringent requirements in applications using very high speed spindles.*

## Optimized design

The ML range is made up of series 7000 and 71900. The internal geometry of these bearings has been optimized to guarantee optimum behavior and operation at limit speeds:

- **Angle of contact 17° and 25°.**
- **Precision 4S.**
- **Phenolic resin cage with improved guidance.**
- **Design optimized for oil lubrication.**



**Residual theoretical average contact angle**

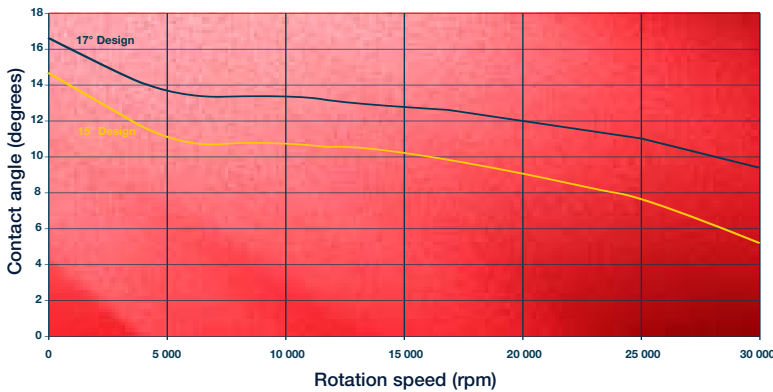

*The graph opposite shows changes in the contact angle of a ML7011CVUJ74S according to rotation speed. The advantage of a 17° design is that it maintains a larger contact angle at top speeds than a 15° design.*

**A « V » is marked on the outside diameter, in direction of the contact angle, to facilitate installation and creation of bearing arrangements.**

## Performance: reducing operating deformations

- Increase rotation speed, while maintaining a load capacity compatible with the service life target for high speed spindles.
- Speed coefficient on the order of  $2.2 \times 10^6$  N.Dm.

**These performance values have been made possible by using smaller balls and more of them.** This design has the major advantage of increasing the ring cross-section, reducing operation deformations.



# MachLine® MLE - Sealed: by definition, a cost-saving solution

## Reduce maintenance costs

SNR has specially developed MLE bearings for machine tool spindles, a part of the trend for simplified mechanisms.

**Conventional lubrication systems** (oil mist, air-oil) **are no longer required with this type of bearing.** These methods are expensive, difficult to maintain

and can cause critical functional failures for spindle use. For grease-lubricated applications, the MLE **bearing means no more complex**, expensive sealing systems and regreasing operations.

## Design and features

The design of these bearings is based on ML bearings, available in series 7000 and 71900:

- **Contact angle 17° and 25°.**
- **Precision 4S.**
- **Non-contact seals:** avoids over-heating linked to friction on seals.
- **Reduced clearance between seal lip and the shoulder of the inner ring:** limiting contaminant entry and avoiding grease leaks.
- Greased in factory by SNR, using optimum quantities of SNR-LUB GV+, recommended by our research and test center.
- Greased in clean room: avoiding contamination during assembly.

**A single « V » is marked on the outside diameter to facilitate assembly and creating bearing arrangements.**



*Use of a MachLine High Speed ML bearing lubricated with SNR LUB GV+ grease can give the same performance values at high speed as a standard bearing lubricated with oil.*

**machline®**



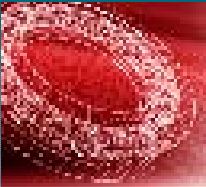

# MachLine® HNS – N: for extreme conditions

*SNR offers MachLine HNS for applications where the bearing is operating at extreme speed or load conditions. It was developed for the aviation and aerospace industries.*

## | General features

This bearing has **stainless steel rings and ceramic balls.**

XD15N steel is a nitrogen-strengthened martensitic

stainless steel, developed by SNR in partnership with Aubert & Duval. It is **highly corrosion-resistant and resistant to wear and surface damage.**

## | Performance of XD15N steel...

Its conventional manufacturing methods using ESR (Electro Slag Remelted) - and its highly machinable property make this a very high performance steel,

with **excellent cleanliness**, guaranteeing greater fatigue resistance than conventional steel.

## | ... and ceramic balls

This bearing uses ceramic balls to give all the lubricant and wear advantages of ceramic-steel contact – high resistance to wear and deterioration (see page 31).

*The SNR research and test center has established coefficient  $a_2$  in calculating the corrected service life for XD15N – a value of 2.8 (see page 20).*





# Spindle types and installation examples

## Classification of spindle applications into broad areas

This classification gives the most usual configurations, but others are possible.

Number of bearings	Bearing	Arrangement	Field of application
4	Front		<b>Light to medium loads – high speeds</b> Installed on boring, milling, drilling units and grinding spindles.
	Rear		
	Front		
	Rear		
5	Front		<b>Heavy loads (single direction axial loads) – medium speeds</b> Very often installed on boring and milling machines, lathes and boring, milling and drilling units.
	Rear		
6	Front		<b>Heavy loads – medium speeds</b> Useful when installed on assemblies where the axial load applies in both directions. For spindles on boring and milling machines, lathes and boring, milling and drilling units.
	Rear		

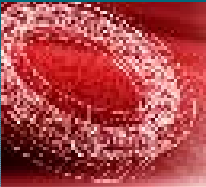

# Spindle types and installation examples

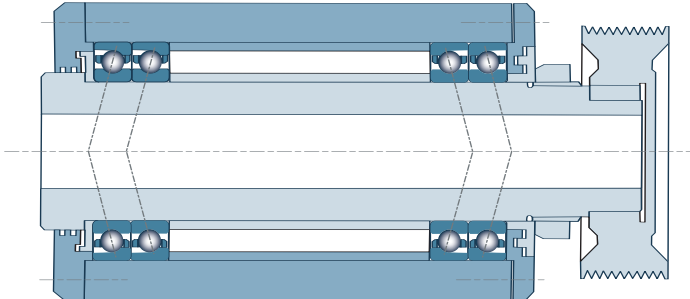

**Example 1:**  
**MachLine Standard bearings**

Q21 installation

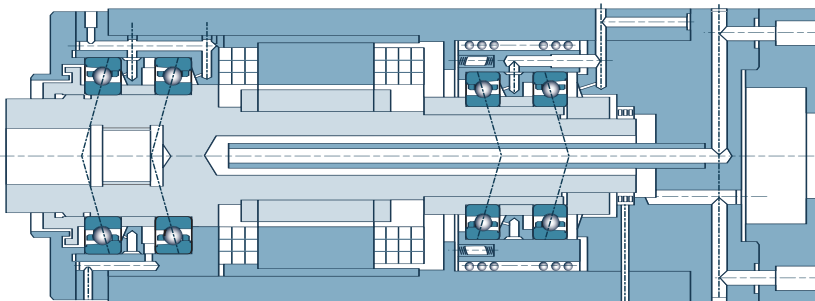

**Example 2:**  
**MachLine ML bearings**

Front bearing: DT installation

Rear bearing: DT installation  
spring preloaded

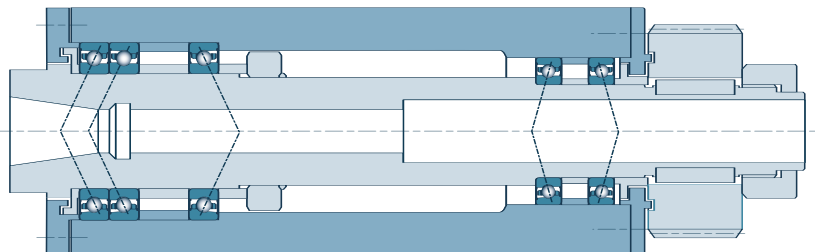

**Example 3:**  
**MachLine MLE bearings**

Front bearing: Q16 installation

Rear bearing: DB installation

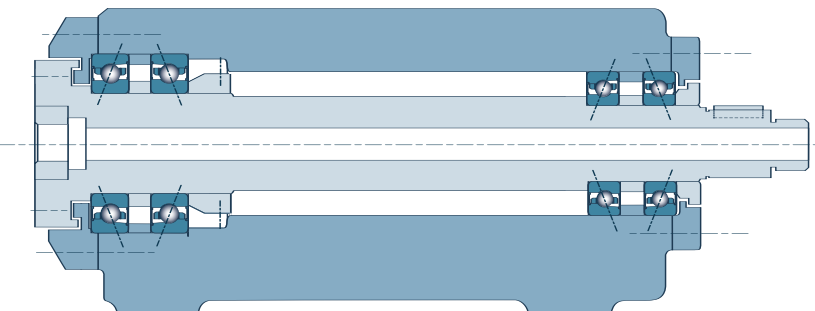

**Example 4:**  
**MachLine MLE bearings**

Front bearing: DB installation

Rear bearing: DB installation

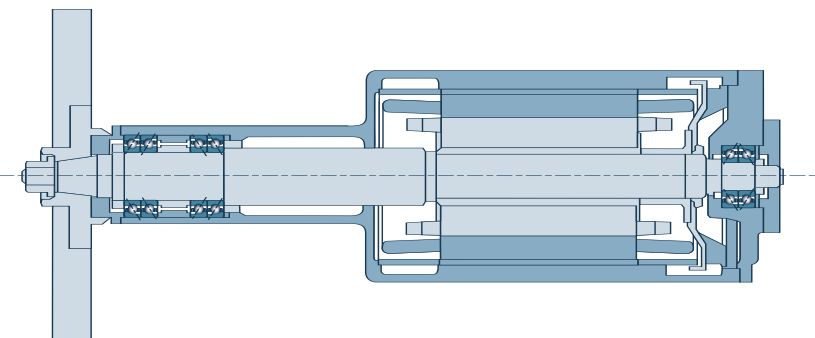

**Example 5:**  
**MachLine Standard bearings**

Front bearing: Q21 installation

Rear bearing: DB installation



# MachLine®

## range

*To help in your choices, the section gives all part numbers, characteristics, tolerances and precision classes for our range of bearings and precision self-locking nuts.*

*You are also provided with a whole range of operational information to facilitate your logistics and make easier to understand our symbol, marking and packaging code systems.*

- Symbols, labelling and packaging 38-39
- MachLine: the ranges 40-51
- Precision self-locking nuts 52-54
- Summary of the ranges 55
- Tolerances and precision classes 56-60

**machline®**





# Symbol system for MachLine® bearings

**12**

**Bore diameter**

Code	Dimensions
00	10 mm
01	12 mm
02	15 mm
03	17 mm
04 x 5	20 mm
05 x 5	25 mm
... x 5	etc...

**719**

**Series**

- 719 (ISO 19)
- 70 (ISO 10)
- 72 (ISO 02)

**ML**

**High Speed range**

**CH** Hybrid bearing

**N** HNS bearing

**\*** Lubrication holes in outer ring

(no code) = Standard ring

L1 L2

**V**

**V High Precision bearings**  
Series 719-70  
Stratified phenolic cage guided by the outer ring

**G1 High load capacity bearing**  
Serie 72  
Stratified phenolic cage guided by the outer ring

**J**

Symbol preceding preload and precision functions

**4S**

**Tolerance classes**

Code	Precision
4	P4S for standard
4S	P4S for ML and MLE
2	ISO 2 (ABEC 9)

**ML E CH 719 12 C V \* U \* J 7 4S \***

**E**

**Sealed bearing**

**C**

**Contact angle  $\alpha$**

Code	Stand.	ML
C	15°	17°
H	25°	25°

**U**

**Association code**

**Universal bearing and association of universal bearings**

- U** Universal single bearing
- DU** Universal pair
- TU** Association of 3 universal bearings
- QU** Association of 4 universal bearings

**Association of paired bearings: identical contact angles**

DB Q16

DF Q21

DT Q18

**Association of paired bearings: different contact angles**

Q34 Q30

**\***

**Specials**

Example:  
D = greased bearing

**7**

**Preload**

Code	Designation
7	Light
8	Medium
9	Heavy
X	Special
0	Not defined

**\***

**(empty) standard bearing**

R = classification of inner and outer diameter



**For other associations, consult SNR**





# Marking and packaging

## Marking

- **Universal bearings:** A single « V » is marked on the outside diameter to facilitate installation. This identification is currently used for ML and MLE bearings and will be gradually incorporated into all ranges in 2006.

- **Matched bearing arrangements:** The « V » marked on the outside diameter shows the position of the bearings in the arrangement, enabling the assembly to be centered at installation (see installation recommendations).



The registration number of the arrangement enables assemblies to be put back together if bearings get mixed up.

The « V » of the arrangement is at 90° angle to the single « V » on the outside diameter.

The « V » of the arrangement is at 90° angle to the single « V » on the outside diameter.

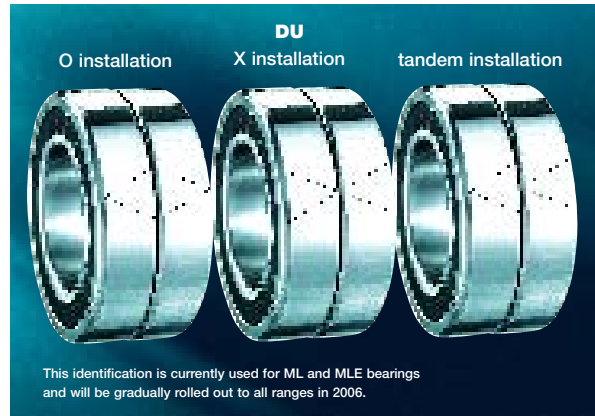

This identification is currently used for ML and MLE bearings and will be gradually rolled out to all ranges in 2006.

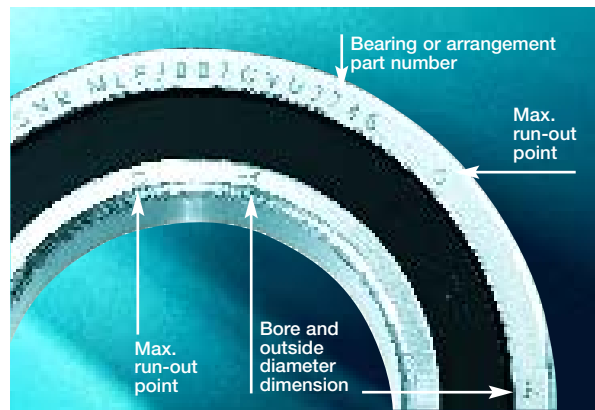

## Packaging

After being coated with an anti-oxidant, MachLine bearings are individually packed in a heat-sealed plastic bag. If the bearing is kept in its original packaging, long-term oxidation protection is guaranteed.

- **Universal bearings.** Information shown on package: bearing part number, packaging date, bore and outside diameter dimensions.

- **Matched bearing arrangements:** for bearing arrangements, boxes containing the bearings are bound with adhesive tape stating "Do not separate". Information shown on package: arrangement part number, packaging date, bore and outside diameter dimensions.



All SNR MachLine bearings have been given a holographic label with several security features as part of our ongoing fight against counterfeiting.

machline





# MachLine®: ranges High Precision - Standard

## | Series 719 / 70 / 72

Dimensions			Weight	Series	Shoulders and fillets					Hole for lubrication		Balls	
d	D	B	kg		D1	d2	D4	Max. r2	Max. r3	D5	E	Diam.	Nb
10	22	6	0,010	<b>71900</b>	17,8	13,6	18,8	0,3	0,1	14,7	1,10	3,175	11
	26	8	0,018	<b>7000</b>	21,4	14,7	22,7	0,3	0,1	16,5	1,85	4,762	10
	30	9	0,030	<b>7200</b>	24,5	16,0	25,5	0,6	0,3	18,2	2,25	5,556	10
12	24	6	0,011	<b>71901</b>	19,6	15,4	20,6	0,3	0,1	16,5	1,30	3,175	13
	28	8	0,020	<b>7001</b>	23,4	16,7	24,7	0,3	0,1	18,5	1,65	4,762	11
	32	10	0,037	<b>7201</b>	26,0	18,3	27,9	0,6	0,3	20,5	1,85	5,953	10
15	28	7	0,015	<b>71902</b>	24,3	18,7	25,4	0,3	0,1	20,0	1,40	3,969	13
	32	9	0,028	<b>7002</b>	26,9	20,2	28,2	0,3	0,1	22,0	1,65	4,762	13
	35	11	0,044	<b>7202</b>	29,0	21,1	31,3	0,6	0,3	23,3	2,10	5,953	11
17	30	7	0,017	<b>71903</b>	26,6	21,0	27,7	0,3	0,1	23,0	1,45	3,969	14
	35	10	0,037	<b>7003</b>	29,4	22,7	30,7	0,3	0,1	24,4	1,75	4,762	14
	40	12	0,065	<b>7203</b>	33,0	24,1	35,2	0,6	0,3	26,5	2,45	6,747	11
20	37	9	0,036	<b>71904</b>	31,9	25,1	33,2	0,3	0,15	26,8	1,78	4,762	15
	42	12	0,063	<b>7004</b>	35,5	26,6	37,3	0,6	0,3	29,0	2,40	6,350	13
	47	14	0,105	<b>7204</b>	38,6	28,5	41,4	1,0	0,3	31,3	2,80	7,938	11
25	42	9	0,041	<b>71905</b>	37,4	30,6	38,7	0,3	0,15	32,3	1,75	4,762	17
	47	12	0,076	<b>7005</b>	40,1	32,2	42,3	0,6	0,3	34,2	2,05	6,350	15
	52	15	0,128	<b>7205</b>	44,5	34,0	46,9	1,0	0,3	36,8	2,80	7,938	13
30	47	9	0,047	<b>71906</b>	41,9	35,1	43,2	0,3	0,15	36,8	1,73	4,762	18
	55	13	0,112	<b>7006</b>	47,0	38,1	49,5	1,0	0,3	40,4	2,35	7,144	16
	62	16	0,200	<b>7206</b>	52,1	40,4	55,4	1,0	0,3	43,5	3,15	9,525	13
35	55	10	0,075	<b>71907</b>	48,6	41,4	50,4	0,6	0,15	43,2	1,85	5,556	18
	62	14	0,150	<b>7007</b>	53,1	43,2	56,3	1,0	0,3	46,0	2,85	7,938	16
	72	17	0,290	<b>7207</b>	61,0	47,4	64,5	1,1	0,3	50,9	3,50	11,112	13
40	62	12	0,110	<b>71908</b>	55,2	46,8	57,2	0,6	0,15	49,0	2,18	6,350	19
	68	15	0,185	<b>7008</b>	59,0	49,2	61,8	1,0	0,3	51,8	2,55	7,938	18
	80	18	0,370	<b>7208</b>	67,6	52,8	71,8	1,1	0,6	56,9	4,05	11,906	13
45	68	12	0,128	<b>71909</b>	60,7	52,3	62,7	0,6	0,3	54,5	2,15	6,350	20
	75	16	0,238	<b>7009</b>	65,0	54,7	68,6	1,0	0,3	57,5	2,85	8,731	18
	85	19	0,416	<b>7209</b>	72,5	57,4	77,5	1,1	0,6	61,7	4,30	12,700	14
50	72	12	0,129	<b>71910</b>	65,2	56,8	67,2	0,6	0,3	58,9	2,13	6,350	21
	80	16	0,256	<b>7010</b>	70,0	59,7	73,6	1,0	0,3	62,5	2,80	8,731	19
	90	20	0,486	<b>7210</b>	76,9	62,5	82,7	1,1	0,6	66,7	4,20	12,700	15
55	80	13	0,181	<b>71911</b>	72,5	62,1	75,8	1,0	0,3	65,4	2,25	7,144	21
	90	18	0,390	<b>7011</b>	80,0	65,0	84,0	1,1	0,6	69,0	2,00	9,525	19
	100	21	0,620	<b>7211</b>	87,0	68,0	92,5	1,5	0,6	72,5	2,10	14,288	14
60	85	13	0,195	<b>71912</b>	77,5	67,1	80,8	1,0	0,3	70,4	2,25	7,144	23
	95	18	0,420	<b>7012</b>	85,0	70,0	89,0	1,1	0,6	73,8	2,00	9,525	21
	110	22	0,810	<b>7212</b>	95,0	75,0	101,5	1,5	0,6	79,5	2,30	15,875	14
65	90	13	0,210	<b>71913</b>	82,5	72,5	86,0	1,0	0,3	74,5	1,25	7,144	27
	100	18	0,440	<b>7013</b>	90,0	75,0	94,0	1,1	0,6	78,8	2,00	9,525	22
	120	23	1,140	<b>7213</b>	104,0	81,0	109,0	1,5	0,6	87,0	2,30	15,875	15
70	100	16	0,340	<b>71914</b>	91,0	79,0	95,0	1,0	0,3	81,5	1,50	8,731	24
	110	20	0,610	<b>7014</b>	98,5	81,5	103,0	1,1	0,6	85,8	2,50	11,112	21
	125	24	1,100	<b>7214</b>	109,0	86,0	116,0	1,5	0,6	91,4	2,60	17,462	14

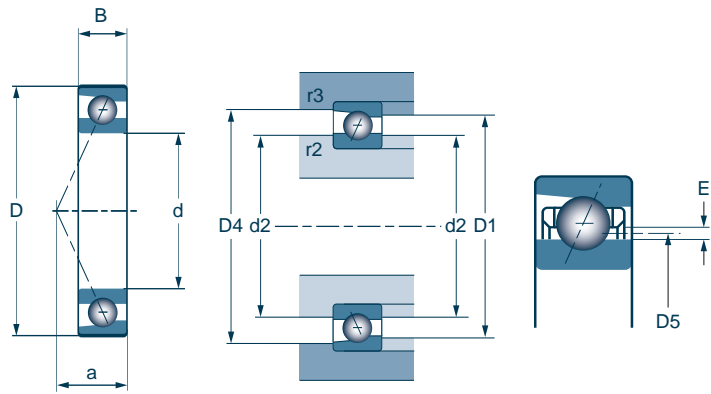

## Series 719 CV 70 CV / 72 CG1

Contact angle  
15°

## Series 719 HV 70 HV / 72 HG1

Contact angle  
25°

Series C	a	Basic load values in N		Limit speed in rpm	
		Dynamic C	Static Co	Grease	Oil
71900CV	5	3 050	1 520	71 000	108 000
7000CV	6	5 700	2 750	60 000	95 000
7200CG1	7	7 500	3 700	53 000	82 000
71901CV	5	3 400	1 860	64 000	97 000
7001CV	7	6 200	3 200	54 000	85 000
7201CG1	8	8 600	4 300	48 000	74 000
71902CV	6	5 100	2 850	52 000	79 000
7002CV	8	7 000	4 000	46 000	72 000
7202CG1	9	9 400	5 000	42 000	65 000
71903CV	7	5 300	3 150	46 000	70 000
7003CV	8	7 400	4 450	41 000	65 000
7203CG1	10	11 600	6 400	37 000	58 000
71904CV	8	7 700	4 900	39 000	60 000
7004CV	10	11 800	7 100	35 000	55 000
7204CG1	11	15 600	8 900	32 000	49 000
71905CV	9	8 300	5 800	33 000	50 000
7005CV	11	13 000	8 600	30 000	47 000
7205CG1	13	17 600	11 100	27 000	42 000
71906CV	10	8 400	6 300	29 000	44 000
7006CV	12	16 700	11 700	25 000	40 000
7206CG1	14	24 400	15 900	23 000	35 000
71907CV	11	11 100	8 500	25 000	38 000
7007CV	13	21 000	15 500	23 000	35 000
7207CG1	16	32 500	21 700	20 000	31 000
71908CV	13	14 700	11 800	21 000	33 000
7008CV	15	21 600	16 800	21 000	33 000
7208CG1	17	36 500	25 000	18 500	29 500
71909CV	14	15 400	10 700	20 000	30 000
7009CV	16	27 400	19 200	19 000	28 000
7209CG1	18	45 900	29 900	16 500	26 000
71910CV	14	15 600	11 300	19 000	28 000
7010CV	17	28 200	20 200	18 000	26 000
7210CG1	19	48 000	32 600	15 500	24 500
71911CV	16	18 700	13 700	16 500	25 000
7011CV	19	30 500	26 000	16 000	24 000
7211CG1	21	53 000	40 000	14 500	21 500
71912CV	16	19 500	15 000	14 500	23 500
7012CV	19	32 500	29 500	15 000	23 000
7212CG1	22	65 000	49 000	12 500	19 500
71913CV	17	21 700	21 900	14 500	22 000
7013CV	20	33 000	31 000	14 000	21 000
7213CG1	24	67 000	54 000	11 500	17 500
71914CV	19	29 500	29 000	13 000	20 000
7014CV	22	43 000	40 000	13 000	20 000
7214CG1	25	77 000	60 000	11 000	16 500

Series H	a	Basic load values in N		Limit speed in rpm	
		Dynamic C	Static Co	Grease	Oil
71900HV	7	2 900	1 450	67 000	103 000
7000HV	8	5 500	2 650	53 000	82 000
7200HG1	9	7 200	3 550	46 000	72 000
71901HV	7	3 250	1 770	61 000	93 000
7001HV	9	6 000	3 050	48 000	72 000
7201HG1	10	8 300	4 200	42 000	65 000
71902HV	9	4 850	2 750	49 000	75 000
7002HV	10	6 700	3 850	42 000	62 000
7202HG1	11	9 100	4 850	37 000	57 000
71903HV	9	5 100	3 000	44 000	68 000
7003HV	11	7 000	4 250	37 000	56 000
7203HG1	13	11 200	6 200	32 000	50 000
71904HV	11	7 300	4 650	37 000	57 000
7004HV	13	11 300	6 800	31 000	47 000
7204HG1	15	15 000	8 500	28 000	43 000
71905HV	12	7 800	5 500	31 000	47 000
7005HV	14	12 400	8 200	26 000	40 000
7205HG1	16	16 900	10 600	24 000	37 000
71906HV	13	8 000	5 900	27 000	42 000
7006HV	16	15 900	11 200	22 000	34 000
7206HG1	19	23 400	15 200	20 000	31 000
71907HV	15	10 500	8 100	23 000	36 000
7007HV	18	20 000	14 800	21 000	31 000
7207HG1	21	31 000	20 700	17 000	27 000
71908HV	18	13 900	11 100	20 000	31 000
7008HV	20	20 500	16 000	20 000	30 000
7208HG1	23	35 000	24 100	16 500	25 500
71909HV	19	14 500	10 100	18 000	26 000
7009HV	22	26 000	18 100	18 000	24 000
7209HG1	25	43 800	28 500	15 000	22 500
71910HV	20	14 700	10 600	16 000	24 000
7010HV	23	26 600	19 300	14 500	22 000
7210HG1	26	45 700	30 800	13 500	20 500
71911HV	22	17 600	12 900	13 500	21 500
7011HV	26	29 000	24 900	14 000	22 000
7211HG1	29	51 000	38 000	12 500	19 500
71912HV	23	18 400	14 200	13 500	20 000
7012HV	27	30 500	28 000	14 000	21 000
7212HG1	31	62 000	47 000	11 000	17 500
71913HV	25	20 400	20 400	14 000	21 000
7013HV	28	31 500	29 500	13 000	19 000
7213HG1	33	64 000	52 000	10 000	16 500
71914HV	28	28 000	27 500	12 500	19 000
7014HV	31	40 500	37 500	12 500	19 000
7214HG1	35	73 000	57 000	9 700	15 000

machine





# MachLine®: ranges

## High Precision - Standard

### | Series 719 / 70 / 72

Dimensions			Weight	Series	Shoulders and fillets					Hole for lubrication		Balls	
d	D	B	kg		D1	d2	D4	Max. r2	Max. r3	D5	E	Diam.	Nb
<b>75</b>	105	16	0,360	<b>71915</b>	96,0	84,0	100,0	1,0	0,3	86,3	1,50	8,731	26
	115	20	0,650	<b>7015</b>	103,5	86,5	108,0	1,1	0,6	90,7	2,50	11,112	22
	130	25	1,200	<b>7215</b>	114,0	91,0	121,0	1,5	0,6	96,4	2,60	17,462	15
<b>80</b>	110	16	0,380	<b>71916</b>	101,0	89,0	105,0	1,0	0,3	91,2	1,50	8,731	27
	125	22	0,850	<b>7016</b>	112,0	93,0	117,5	1,1	0,6	98,0	3,50	13,494	20
	140	26	1,470	<b>7216</b>	122,5	97,5	130,0	2,0	1,0	103,4	2,80	19,050	15
<b>85</b>	120	18	0,550	<b>71917</b>	110,0	95,0	114,0	1,1	0,6	98,6	1,80	9,525	27
	130	22	0,900	<b>7017</b>	117,0	98,0	122,5	1,1	0,6	102,8	3,50	13,494	21
	150	28	1,810	<b>7217</b>	131,0	104,0	140,0	2,0	1,0	110,3	3,10	20,638	15
<b>90</b>	125	18	0,580	<b>71918</b>	115,0	100,0	119,0	1,1	0,6	103,5	1,80	9,525	29
	140	24	1,160	<b>7018</b>	125,5	104,5	131,5	1,5	0,6	110,0	3,80	15,081	20
	160	30	2,240	<b>7218</b>	139,0	111,0	149,0	2,0	1,0	117,2	3,30	22,225	15
<b>95</b>	130	18	0,590	<b>71919</b>	120,0	105,0	124,0	1,1	0,6	108,3	2,00	10,319	28
	145	24	1,210	<b>7019</b>	130,5	109,5	136,5	1,5	0,6	114,8	3,80	15,081	21
<b>100</b>	140	20	0,820	<b>71920</b>	128,5	111,5	133,5	1,1	0,6	115,6	2,10	11,112	28
	150	24	1,270	<b>7020</b>	135,5	114,5	141,5	1,5	0,6	119,7	3,80	15,081	22
	180	34	3,230	<b>7220</b>	155,5	124,5	167,0	2,1	1,1	131,0	3,80	25,400	14
<b>105</b>	145	20	0,860	<b>71921</b>	133,5	116,5	138,5	1,1	0,6	120,5	2,10	11,112	29
	160	26	1,610	<b>7021</b>	144,5	120,5	150,0	2,0	1,0	127,0	4,00	15,875	22
<b>110</b>	150	20	0,890	<b>71922</b>	138,5	121,5	143,5	1,1	0,6	125,5	2,10	11,112	30
	170	28	2,000	<b>7022</b>	153,0	127,0	160,0	2,0	1,0	134,0	4,50	17,462	21
	200	38	4,530	<b>7222</b>	172,5	137,5	185,5	2,1	1,1	145,0	4,30	28,575	14
<b>120</b>	165	22	1,190	<b>71924</b>	151,5	133,5	157,5	1,1	0,6	137,7	3,30	13,494	28
	180	28	2,150	<b>7024</b>	163,0	137,0	170,0	2,0	1,0	144,0	4,50	17,462	23
	215	40	5,600	<b>7224</b>	185,5	149,5	197,5	2,1	1,1	157,5	4,30	28,575	16
<b>130</b>	180	24	1,570	<b>71926</b>	165,0	145,0	172,0	1,5	0,6	149,8	3,70	15,081	27
	200	33	3,180	<b>7026</b>	179,5	150,5	189,0	2,0	1,0	158,0	5,30	20,638	21
<b>140</b>	190	24	1,680	<b>71928</b>	175,0	155,0	182,0	1,5	0,6	159,8	3,70	15,081	29
	210	33	3,420	<b>7028</b>	189,5	160,5	199,0	2,0	1,0	168,0	5,30	20,638	23
<b>150</b>	210	28	2,620	<b>71930</b>	192,5	167,5	199,0	2,0	1,0	174,0	4,10	16,669	29
	225	35	4,160	<b>7030</b>	203,0	172,0	213,0	2,1	1,0	180,0	5,70	22,225	23
<b>160</b>	220	28	2,760	<b>71932</b>	202,5	177,5	209,0	2,0	1,0	184,0	4,10	16,669	30
	240	38	5,130	<b>7032</b>	216,0	184,0	227,0	2,1	1,0	192,0	6,20	23,812	23
<b>170</b>	230	28	2,910	<b>71934</b>	212,5	187,5	219,0	2,0	1,0	194,0	4,10	16,669	32
	260	42	6,980	<b>7034</b>	232,5	197,5	246,0	2,1	1,1	206,4	6,60	25,400	23
<b>180</b>	250	33	4,260	<b>71936</b>	229,0	201,0	237,5	2,0	1,0	208,3	4,70	19,050	30
	280	46	9,000	<b>7036</b>	249,5	210,5	264,0	2,1	1,1	219,8	7,80	30,163	21
<b>190</b>	260	33	4,480	<b>71938</b>	239,0	211,0	247,5	2,0	1,0	218,3	4,70	19,050	32
	290	46	9,400	<b>7038</b>	259,5	220,5	274,0	2,1	1,1	229,8	7,80	30,163	22
<b>200</b>	280	38	6,160	<b>71940</b>	255,5	224,5	266,0	2,1	1,0	232,0	5,50	23,812	27
	310	51	12,150	<b>7040</b>	276,5	233,5	292,0	2,1	1,1	243,6	8,60	33,338	21
<b>220</b>	300	38	6,770	<b>71944</b>	275,5	244,5	286,0	2,1	1,0	252,0	5,50	22,225	31
	340	56	16,280	<b>7044</b>	304,0	256,0	321,0	3,0	1,1	268,6	8,60	33,338	23
<b>240</b>	320	38	7,270	<b>71948</b>	295,5	264,5	306,0	2,1	1,0	272,0	5,50	22,225	33

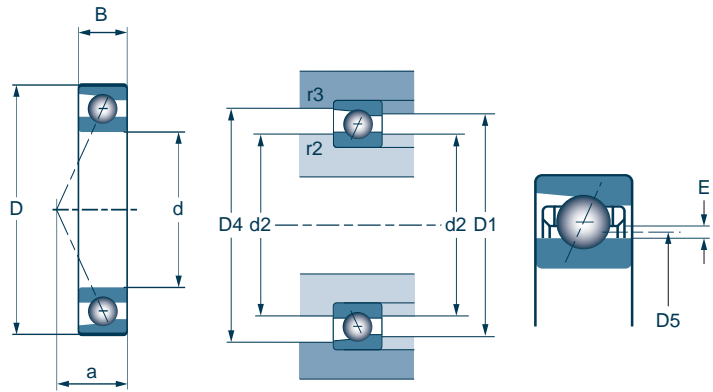

## Series 719 CV 70 CV / 72 CG1

Contact angle  
15°

## Series 719 HV 70 HV / 72 HG1

Contact angle  
25°

Series C	a	Basic load values in N		Limit speed in rpm	
		Dynamic C	Static Co	Grease	Oil
71915CV	20	30 500	31 500	12 500	19 000
7015CV	23	44 000	42 000	12 000	19 000
7215CG1	26	80 000	65 000	10 000	16 000
71916CV	21	31 000	33 000	12 000	18 000
7016CV	25	59 000	55 000	11 000	17 000
7216CG1	28	94 000	78 000	9 400	15 000
71917CV	23	36 500	39 000	11 000	17 000
7017CV	25	61 000	59 000	10 500	16 000
7217CG1	30	108 000	91 000	8 700	14 000
71918CV	23	38 000	41 500	10 500	16 000
7018CV	27	73 000	69 000	10 000	15 000
7218CG1	32	124 000	105 000	8 100	12 500
71919CV	24	43 000	47 500	9 900	15 000
7019CV	28	74 000	73 000	9 700	14 500
71920CV	26	49 000	55 000	9 500	14 500
7020CV	29	76 000	77 000	9 300	14 000
7220CG1	36	150 000	127 000	7 200	11 000
71921CV	27	50 000	57 000	9 200	14 000
7021CV	31	84 000	86 000	8 800	13 500
71922CV	27	51 000	59 000	8 900	13 500
7022CV	33	97 000	98 000	8 300	12 500
7222CG1	40	177 000	160 000	6 300	9 700
71924CV	30	70 000	81 000	8 200	12 500
7024CV	34	102 000	109 000	7 700	11 500
7224CG1	42	193 000	187 000	5 700	8 700
71926CV	33	84 000	98 000	7 500	11 500
7026CV	39	131 000	137 000	7 000	10 500
71928CV	34	87 000	105 000	7 200	11 000
7028CV	40	138 000	152 000	6 600	10 000
71930CV	38	105 000	128 000	6 500	9 000
7030CV	43	158 000	176 000	6 200	9 300
71932CV	39	106 000	132 000	6 200	9 400
7032CV	46	179 000	202 000	5 800	8 800
71934CV	41	107 000	140 000	5 800	8 900
7034CV	50	200 000	230 000	5 400	8 100
71936CV	45	135 000	173 000	5 400	8 300
7036CV	54	244 000	290 000	5 000	7 600
71938CV	47	139 000	183 000	5 200	7 900
7038CV	55	250 000	305 000	4 800	7 300
71940CV	51	192 000	243 000	4 800	7 400
7040CV	60	280 000	355 000	4 500	6 900
71944CV	54	180 000	242 000	4 400	6 800
7044CV	66	295 000	395 000	4 100	6 200
71948CV	57	185 000	255 000	4 200	6 400

Series H	a	Basic load values in N		Limit speed in rpm	
		Dynamic C	Static Co	Grease	Oil
71915HV	29	29 000	29 500	12 000	18 000
7015HV	32	41 500	40 000	11 000	17 000
7215HG1	36	76 000	62 000	9 100	14 500
71916HV	30	29 500	30 500	11 000	17 000
7016HV	35	56 000	53 000	10 500	16 000
7216HG1	39	89 000	74 000	8 500	13 000
71917HV	33	34 500	36 500	9 900	15 000
7017HV	36	58 000	56 000	9 900	15 000
7217HG1	41	103 000	86 000	7 800	12 000
71918HV	34	35 500	39 000	9 900	15 000
7018HV	39	69 000	66 000	9 200	14 000
7218HG1	44	118 000	100 000	7 300	11 000
71919HV	35	40 500	44 000	9 200	14 000
7019HV	40	71 000	69 000	8 900	13 500
71920HV	38	46 000	51 000	8 600	13 000
7020HV	41	72 000	73 000	8 600	13 000
7220HG1	50	143 000	121 000	6 400	9 800
71921HV	39	47 000	53 000	8 600	13 000
7021HV	44	79 000	81 000	7 900	12 000
71922HV	40	47 500	55 000	8 200	12 500
7022HV	47	92 000	93 000	7 600	11 500
7222HG1	55	169 000	153 000	5 600	8 700
71924HV	44	66 000	76 000	7 500	11 500
7024HV	49	96 000	103 000	6 900	10 500
7224HG1	59	184 000	178 000	5 100	7 800
71926HV	48	79 000	92 000	6 900	10 500
7026HV	55	124 000	130 000	6 500	9 800
71928HV	50	82 000	98 000	6 400	9 800
7028HV	57	130 000	144 000	6 100	9 200
71930HV	56	99 000	120 000	5 900	9 000
7030HV	61	149 000	167 000	5 700	8 600
71932HV	58	100 000	123 000	5 600	8 500
7032HV	66	169 000	191 000	5 300	8 100
71934HV	61	103 000	131 000	5 300	8 100
7034HV	71	189 000	218 000	5 000	7 500
71936HV	67	127 000	161 000	4 900	7 500
7036HV	77	231 000	275 000	4 600	7 000
71938HV	69	131 000	171 000	4 700	7 200
7038HV	79	237 000	290 000	4 400	6 700
71940HV	75	181 000	229 000	4 400	6 800
7040HV	85	265 000	335 000	4 200	6 300
71944HV	77	170 000	226 000	4 000	6 200
7044HV	93	280 000	375 000	3 700	5 700
71948HV	84	174 000	238 000	3 800	5 800

machline





# MachLine®: ranges

## High Precision - Standard

### Preload, axial and radial rigidity of DU DB DF arrangements

Symbol	Deflection constant	Preload (N)			Axial rigidity (N/μm)			Radial rigidity (N/μm)		
		7	8	9	7	8	9	7	8	9
	K (1)									
71900CV	2,58	12	40	75	13	21	29	72	104	125
7000CV	2,33	25	80	160	17	30	43	100	141	171
7200CG1	2,12	40	120	230	23	39	54	128	178	214
71900HV	1,25	22	70	140	32	50	65	67	95	117
7000HV	1,14	45	130	260	42	65	87	90	124	152
7200HG1	1,03	60	180	360	54	81	110	111	157	194
71901CV	2,31	15	43	85	15	24	34	87	120	146
7001CV	2,19	30	90	180	20	33	48	113	158	192
7201CG1	2,11	42	130	250	24	39	54	135	186	227
71901HV	1,12	25	75	150	37	56	74	78	110	135
7001HV	1,06	50	140	280	47	70	95	101	138	169
7201HG1	1,03	70	200	400	56	84	112	119	168	207
71902CV	2,18	22	70	140	18	29	42	105	150	184
7002CV	2,06	32	100	200	22	38	55	123	174	212
7202CG1	1,98	45	130	270	25	41	59	149	203	249
71902HV	1,05	35	110	220	44	68	89	93	133	164
7002HV	1,00	55	160	320	54	82	110	111	154	190
7202HG1	0,97	75	220	440	61	93	123	132	182	225
71903CV	2,08	25	75	150	20	32	45	115	162	198
7003CV	1,87	35	105	210	24	41	59	141	197	240
7203CG1	1,81	60	170	350	29	48	69	164	224	275
71903HV	1,00	40	120	240	49	73	96	102	144	178
7003HV	0,91	60	170	340	58	88	115	127	175	216
7203HG1	0,92	90	280	560	69	106	143	141	200	244
71904CV	1,79	35	110	220	26	43	61	148	210	257
7004CV	1,65	60	180	360	33	57	84	185	257	312
7204CG1	1,58	85	260	500	38	66	94	205	284	340
71904HV	0,87	55	170	340	62	95	125	130	186	229
7004HV	0,81	100	300	600	78	120	165	165	231	283
7204HG1	0,80	140	410	820	91	139	189	182	251	305
71905CV	1,64	40	120	240	29	48	67	169	236	289
7005CV	1,50	70	200	400	38	65	95	215	295	358
7205CG1	1,45	100	300	600	45	77	112	245	340	413
71905HV	0,80	60	180	360	70	105	138	146	207	256
7005HV	0,74	110	320	640	88	135	180	189	263	323
7205HG1	0,72	150	450	900	104	159	216	210	294	358
71906CV	1,59	40	120	240	30	50	69	176	246	302
7006CV	1,43	85	250	500	43	72	105	246	341	416
7206CG1	1,33	130	380	760	49	82	117	283	389	472
71906HV	0,77	60	190	380	72	111	146	153	220	271
7006HV	0,70	130	400	800	98	150	205	212	300	368
7206HG1	0,68	200	600	1200	117	177	239	247	346	423
71907CV	1,45	55	165	330	37	61	86	211	295	361
7007CV	1,30	100	300	600	50	84	120	285	398	486
7207CG1	1,32	180	530	1000	60	102	142	333	460	551
71907HV	0,70	90	260	520	91	135	177	189	263	325
7007HV	0,63	170	500	1000	118	180	245	257	360	443
7207HG1	0,65	280	840	1700	142	217	296	294	414	512

(1) Axial deflection constant in μm (daN)<sup>-2/3</sup> 7 = light preload 8 = medium preload 9 = heavy preload



Symbol	Deflection constant K (1)	Preload (N)			Axial rigidity (N/μm)			Radial rigidity (N/μm)		
		7	8	9	7	8	9	7	8	9
71908CV	1,29	75	230	460	46	77	109	260	365	445
7008CV	1,25	110	330	660	53	91	130	306	427	521
7208CG1	1,37	185	560	1100	58	98	137	332	466	566
71908HV	0,63	120	360	720	111	168	225	230	325	401
7008HV	0,61	180	530	1100	125	190	265	273	383	476
7208HG1	0,67	300	900	1800	142	215	288	297	420	518
71909CV	1,20	80	230	460	49	79	112	272	376	467
7009CV	1,24	130	400	800	60	105	150	333	500	625
7209CG1	1,33	230	700	1400	71	119	171	394	567	713
71909HV	0,59	120	360	720	115	173	232	240	339	422
7009HV	0,61	210	650	1300	140	220	300	292	431	545
7209HG1	0,63	370	1100	2200	169	257	346	352	504	629
71910CV	1,13	80	230	460	50	81	115	278	386	479
7010CV	1,15	140	420	840	64	110	160	356	524	667
7210CG1	1,29	240	720	1440	75	125	178	417	595	742
71910HV	0,55	120	370	740	119	180	241	248	353	438
7010HV	0,56	220	670	1330	145	230	310	302	451	564
7210HG1	0,61	380	1140	2280	177	271	363	369	531	660
71911CV	1,08	90	280	560	52	87	122	370	495	614
7011CV	1,12	180	480	1040	71	112	166	400	538	671
7211CG1	1,20	320	800	1600	80	122	173	449	592	723
71911HV	0,53	150	440	880	130	193	257	325	438	543
7011HV	0,55	280	720	1500	167	240	325	351	472	589
7211HG1	0,57	500	1250	2500	188	267	356	394	525	647
71912CV	1,03	100	300	600	58	94	132	401	534	667
7012CV	1,05	200	540	1160	79	125	184	443	598	744
7212CG1	1,15	400	1000	2000	90	136	193	501	660	806
71912HV	0,50	150	460	920	137	208	276	354	475	592
7012HV	0,51	320	800	1700	187	266	363	393	523	657
7212HG1	0,56	600	1500	3000	207	294	390	434	579	713
71913CV	0,97	150	400	860	77	122	180	432	582	724
7013CV	1,01	220	560	1220	85	130	193	471	625	781
7213CG1	1,09	420	1050	2100	95	145	205	533	703	859
71913HV	0,48	240	600	1260	183	260	354	384	512	641
7013HV	0,50	340	860	1750	197	282	378	414	553	686
7213HG1	0,52	620	1550	3100	218	310	412	460	613	756
71914CV	0,98	200	520	1120	84	131	194	470	623	782
7014CV	0,99	280	720	1550	93	144	213	521	693	864
7214CG1	1,11	460	1150	2300	96	146	207	542	716	875
71914HV	0,48	310	800	1640	196	283	381	413	557	692
7014HV	0,49	420	1100	2250	215	311	419	453	613	760
7214HG1	0,53	720	1800	3600	227	322	428	477	636	784
71915CV	0,93	220	580	1220	92	144	210	512	686	849
7015CV	0,96	300	760	1650	99	151	225	550	728	910
7215CG1	1,07	480	1200	2400	102	155	219	576	761	931
71915HV	0,46	340	860	1800	214	306	416	450	602	753
7015HV	0,47	460	1160	2400	229	327	442	482	644	802
7215HG1	0,51	740	1850	3700	239	339	451	505	673	830

machine





# MachLine®: ranges

## High Precision - Standard

### Preload, axial and radial rigidity of DU DB DF arrangements

Symbol	Deflection constant	Preload (N)			Axial rigidity (N/μm)			Radial rigidity (N/μm)		
		7	8	9	7	8	9	7	8	9
71916CV	0,91	220	600	1280	94	149	220	525	712	885
7016CV	0,97	380	1000	2150	106	166	244	596	799	996
7216CG1	1,03	580	1450	2900	112	170	241	632	834	1020
71916HV	0,45	360	900	1850	224	319	430	470	627	780
7016HV	0,47	600	1500	3150	250	356	484	527	702	879
7216HG1	0,50	880	2200	4400	261	370	491	550	734	905
71917CV	0,88	280	720	1550	105	163	242	585	778	969
7017CV	0,93	400	1060	2250	112	175	256	627	842	1045
7217CG1	1,01	660	1650	3300	120	182	256	678	895	1095
71917HV	0,43	420	1080	2250	242	349	473	510	685	856
7017HV	0,46	620	1600	3300	261	376	507	551	741	923
7217HG1	0,49	1000	2500	5000	279	396	525	590	787	971
71918CV	0,84	300	760	1650	113	174	258	628	832	1039
7018CV	0,93	480	1260	2700	119	186	274	669	896	1115
7218CG1	1,00	760	1900	3800	129	195	275	728	962	1177
71918HV	0,41	460	1160	2400	262	375	507	551	736	917
7018HV	0,45	740	1900	3950	278	400	541	586	788	984
7218HG1	0,47	1160	2900	5800	301	426	566	635	847	1045
71919CV	0,84	320	860	1850	115	182	269	645	870	1084
7019CV	0,90	500	1320	2800	125	195	286	700	940	1167
71919HV	0,41	520	1300	2700	274	390	528	576	768	958
7019HV	0,44	780	2000	4150	293	421	569	617	829	1034
71920CV	0,82	380	1000	2150	125	196	290	699	937	1167
7020CV	0,87	520	1400	2950	130	206	300	732	988	1225
7220CG1	0,99	920	2300	4600	137	207	292	775	1024	1252
71920HV	0,40	600	1500	3150	294	419	570	619	825	1033
7020HV	0,43	820	2100	4350	307	441	596	647	869	1084
7220HG1	0,48	1400	3500	7000	319	453	601	675	901	1112
71921CV	0,80	400	1040	2200	131	203	298	728	972	1205
7021CV	0,86	580	1550	3300	138	216	318	772	1040	1292
71921HV	0,39	620	1600	3250	304	439	590	641	863	1069
7021HV	0,42	920	2350	4850	325	466	629	684	918	1142
71922CV	0,78	420	1080	2300	136	211	310	757	1007	1251
7022CV	0,86	680	1800	3800	146	228	333	815	1094	1356
7222CG1	0,96	1080	2700	5400	149	225	316	852	1126	1379
71922HV	0,38	640	1650	3400	315	454	613	662	892	1110
7022HV	0,42	1060	2700	5600	341	488	660	717	962	1199
7222HG1	0,46	1660	4150	8300	351	497	658	744	993	1226
71924CV	0,77	560	1460	3100	152	237	348	849	1135	1409
7024CV	0,80	740	1950	4200	159	248	367	891	1194	1489
7224CG1	0,89	1140	2850	5700	165	248	347	949	1257	1541
71924HV	0,37	880	2200	4600	357	508	690	750	1001	1251
7024HV	0,39	1160	3000	6150	373	538	724	786	1059	1315
7224HG1	0,42	1720	4300	8600	387	546	721	824	1101	1361

(1) Axial deflection constant in μm (daN)<sup>-2/3</sup> 7 = light preload 8 = medium preload 9 = heavy preload





Symbol	Deflection constant	Preload (N)			Axial rigidity (N/μm)			Radial rigidity (N/μm)		
		7	8	9	7	8	9	7	8	9
71926CV	0,76	660	1750	3750	163	255	376	909	1221	1520
7026CV	0,81	940	2450	5250	171	266	391	960	1283	1597
71926HV	0,37	1040	2650	5500	382	548	741	804	1078	1345
7026HV	0,40	1480	3750	7750	402	576	777	847	1135	1413
71928CV	0,72	720	1900	4000	176	275	402	981	1316	1630
7028CV	0,76	1040	2700	5800	188	292	431	1054	1408	1754
71928HV	0,35	1140	2900	5950	413	593	798	869	1165	1449
7028HV	0,37	1650	4150	8550	444	633	854	934	1247	1552
71930CV	0,70	880	2300	4850	194	303	443	1084	1450	1797
7030CV	0,74	1200	3150	6700	202	315	463	1134	1519	1887
71930HV	0,34	1380	3500	7250	455	652	882	958	1283	1599
7030HV	0,36	1900	4850	9900	477	681	919	1003	1342	1671
71932CV	0,68	920	2400	5100	202	314	462	1126	1505	1868
7032CV	0,73	1380	3600	7650	217	337	494	1215	1625	2019
71932HV	0,33	1440	3650	7550	472	676	915	994	1331	1658
7032HV	0,36	2150	5500	11350	508	729	984	1070	1437	1789
71934CV	0,65	980	2550	5400	215	335	491	1200	1603	1989
7034CV	0,71	1550	4100	8700	230	360	527	1291	1734	2152
71934HV	0,32	1550	3900	8100	505	722	978	1063	1421	1772
7034HV	0,35	2450	6250	12950	542	778	1051	1142	1532	1909
71936CV	0,65	1200	3150	6650	231	360	527	1286	1722	2134
7036CV	0,71	2000	5150	10950	250	385	565	1401	1866	2318
71936HV	0,32	1850	4800	9850	536	775	1045	1129	1524	1894
7036HV	0,35	3100	7950	16350	584	839	1130	1231	1654	2057
71938CV	0,62	1280	3350	7050	246	384	561	1372	1835	2273
7038CV	0,69	2100	5450	11500	260	406	592	1470	1962	2431
71938HV	0,31	2000	5100	10550	575	826	1116	1210	1624	2023
7038HV	0,34	3300	8350	17200	615	880	1186	1296	1735	2159
71940CV	0,65	1650	4350	9100	257	402	585	1436	1926	2382
7040CV	0,69	2400	6300	13350	274	426	624	1540	2063	2561
71940HV	0,32	2600	6600	13600	603	864	1176	1270	1702	2118
7040HV	0,34	3800	9650	19900	646	925	1247	1362	1825	2271
71944CV	0,61	1700	4400	9300	279	433	634	1554	2072	2569
7044CV	0,65	2700	7200	15400	304	477	702	1700	2288	2846
71944HV	0,30	2650	6750	13850	651	934	1259	1370	1838	2284
7044HV	0,32	4250	10900	22500	713	1026	1385	1502	2018	2511
71948CV	0,58	1800	4700	10000	296	461	678	1652	2208	2743
71948HV	0,28	2850	7250	14900	696	998	1347	1464	1962	2440



# MachLine®: ranges

## High Speed and Sealed - ML & MLE

### | Series 719 / 70

Dimensions			Weight	Series	Shoulders and fillets						Hole for lubrication		Balls	
d	D	B	kg		D1	d2	d3	D4	r2	r3	D5	E	Diam.	Nb
10	22	6	0,010	ML 71900	17,2	13,3	13,6	17,8	0,3	0,1	14,4	1,05	2,381	14
	26	8	0,018	ML 7000	19,5	14,2	14,7	20,1	0,3	0,1	15,7	1,53	3,175	11
12	24	6	0,011	ML 71901	19,0	15,1	15,4	19,6	0,3	0,1	16,2	1,05	2,381	14
	28	8	0,020	ML 7001	21,5	16,2	16,7	22,1	0,3	0,1	17,7	1,58	3,175	13
15	28	7	0,015	ML 71902	23,3	18,3	18,7	23,7	0,3	0,1	19,7	1,35	2,778	16
	32	9	0,028	ML 7002	25,7	19,4	20,2	26,8	0,3	0,1	21,3	1,85	3,969	13
17	30	7	0,017	ML 71903	25,6	20,6	21,0	26,0	0,3	0,1	22,0	1,35	2,778	18
	35	10	0,037	ML 7003	28,4	22,0	22,7	29,5	0,3	0,1	23,9	1,85	3,969	15
20	37	9	0,036	ML 71904	30,7	24,5	25,1	31,8	0,3	0,2	26,3	1,75	3,969	16
	42	12	0,063	ML 7004	34,3	25,3	26,6	35,7	0,6	0,3	27,9	2,63	5,556	14
25	42	9	0,041	ML 71905	36,2	30,0	30,6	37,3	0,3	0,2	31,8	1,75	3,969	19
	47	12	0,076	ML 7005	39,9	30,9	32,2	41,3	0,6	0,3	33,5	2,63	5,556	17
30	47	9	0,047	ML 71906	40,7	34,5	35,1	41,8	0,3	0,2	36,2	1,73	3,969	22
	55	13	0,112	ML 7006	45,8	36,8	38,1	47,2	1,0	0,3	39,4	2,63	5,556	20
35	55	10	0,075	ML 71907	47,1	40,8	41,4	48,2	0,6	0,2	42,7	1,90	3,969	26
	62	14	0,149	ML 7007	51,5	41,5	43,2	53,6	1,0	0,3	44,6	3,10	6,350	20
40	62	12	0,109	ML 71908	53,1	45,3	46,8	54,4	0,6	0,2	47,6	2,25	4,762	25
	68	15	0,185	ML 7008	57,5	47,5	49,2	59,6	1,0	0,3	50,5	3,00	6,350	22
45	68	12	0,128	ML 71909	58,6	50,8	52,3	59,9	0,6	0,3	53,0	2,23	4,762	28
	75	16	0,238	ML 7009	63,0	53,0	54,7	65,0	1,0	0,3	56,1	3,05	6,350	22
50	72	12	0,129	ML 71910	63,1	55,3	56,8	64,4	0,6	0,3	57,5	2,23	4,762	30
	80	16	0,256	ML 7010	68,0	58,0	59,7	70,0	1,0	0,3	61,0	3,00	6,350	25
55	80	13	0,177	ML 71911	73,8	60,5	62,2	76,0	1,0	0,3	64,3	2,50	5,556	30
	90	18	0,396	ML 7011	79,5	65,5	66,5	83,5	1,1	0,6	69,5	1,70	7,938	22
60	85	13	0,190	ML 71912	78,8	65,6	67,1	81,0	1,0	0,3	69,3	2,50	5,556	32
	95	18	0,426	ML 7012	84,5	70,5	71,5	88,5	1,1	0,6	74,4	1,67	7,938	24
65	90	13	0,202	ML 71913	83,5	70,5	72,5	86,5	1,0	0,3	75,0	1,25	6,350	29
	100	18	0,445	ML 7013	89,5	74,0	76,5	93,5	1,1	0,6	79,4	1,67	7,938	26
70	100	16	0,330	ML 71914	92,0	76,5	79,0	95,5	1,0	0,3	81,9	1,63	7,938	26
	110	20	0,625	ML 7014	98,0	81,5	83,0	102,5	1,1	0,6	86,4	2,07	9,525	24
75	105	16	0,349	ML 71915	97,0	81,5	84,0	100,5	1,0	0,3	86,9	1,63	7,938	28
	115	20	0,658	ML 7015	103,0	86,5	88,0	107,5	1,1	0,6	91,4	2,07	9,525	25
80	110	16	0,370	ML 71916	102,0	86,5	89,0	105,5	1,0	0,3	91,9	1,63	7,938	30
	125	22	0,874	ML 7016	111,5	93,0	94,5	116,5	1,1	0,6	98,4	2,49	11,113	23
85	120	18	0,535	ML 71917	110,0	93,0	96,0	114,0	1,1	0,6	99,2	1,94	8,731	29
	130	22	0,927	ML 7017	116,5	98,5	99,5	121,5	1,1	0,6	103,4	2,49	11,113	25
90	125	18	0,562	ML 71918	115,0	98,5	101,0	119,0	1,1	0,6	104,2	1,94	8,731	31
	140	24	1,192	ML 7018	124,5	103,0	106,5	130,0	1,5	0,6	110,5	2,64	11,906	25
95	130	18	0,591	ML 71919	120,0	103,5	106,0	124,0	1,1	0,6	109,2	1,94	8,731	32
	145	24	1,263	ML 7019	129,5	109,5	111,5	135,0	1,5	0,6	115,5	2,64	11,906	26
100	140	20	0,796	ML 71920	128,5	109,5	112,5	133,0	1,1	0,6	115,9	2,02	10,319	29
	150	24	1,313	ML 7020	134,5	114,5	116,5	140,0	1,5	0,6	120,5	2,61	11,906	27
105	160	26	1,602	ML 7021	143,0	119,0	123,0	149,0	2,0	1,0	127,5	3,02	13,494	25
110	150	20	0,868	ML 71922	138,5	119,5	122,5	143,0	1,1	0,6	125,9	1,98	10,319	32
	170	28	2,019	ML 7022	150,5	126,0	130,0	149,0	2,0	1,0	134,7	3,23	14,288	25
120	165	22	1,204	ML 71924	151,5	131,0	134,5	156,5	1,1	6,0	138,1	2,18	11,113	33
	180	28	2,167	ML 7024	160,5	136,0	140,0	167,5	2,0	1,0	144,7	3,23	14,288	27
130	180	24	1,572	ML 71926	165,0	142,0	146,0	170,5	1,5	0,6	150,0	2,56	12,700	31
	200	33	3,306	ML 7026	177,0	148,5	154,0	185,0	2,0	1,0	158,9	3,84	16,669	26

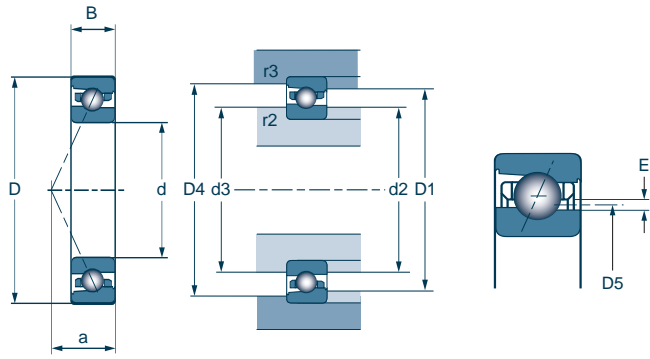
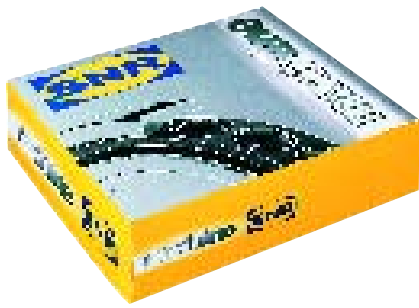

## Series 719 CV 70 CV

Contact angle  
17°

## Series 719 HV 70 HV

Contact angle  
25°

Series C	a	Basic load values in N		Limit speed in rpm	
		Dynamic C	Static Co	Grease	Oil
ML 71900	C 5	1 430	680	101 500	135 000
ML 7000	C 6	2 040	920	94 000	125 000
ML 71901	C 5	1 490	705	90 000	120 000
ML 7001	C 7	2 280	1 110	82 500	110 000
ML 71902	C 6	2 030	1 030	75 000	100 000
ML 7002	C 8	3 450	1 710	69 000	92 000
ML 71903	C 7	2 170	1 180	67 500	90 000
ML 7003	C 8	3 750	2 020	61 500	82 000
ML 71904	C 8	3 900	2 080	56 500	75 000
ML 7004	C 10	6 550	3 600	52 500	70 000
ML 71905	C 9	4 300	2 550	47 500	63 000
ML 7005	C 11	7 450	4 500	44 500	59 000
ML 71906	C 10	4 650	3 000	41 500	55 000
ML 7006	C 12	8 300	5 150	37 500	50 000
ML 71907	C 11	5 100	3 600	35 500	47 000
ML 7007	C 13	10 500	6 700	33 000	44 000
ML 71908	C 13	6 950	4 950	31 500	42 000
ML 7008	C 15	11 000	7 500	29 500	39 000
ML 71909	C 14	7 350	5 550	28 500	38 000
ML 7009	C 16	10 900	7 600	27 000	36 000
ML 71910	C 14	7 600	6 000	26 500	35 000
ML 7010	C 17	11 700	8 700	25 000	33 000
ML 71911	C 16	10 100	8 200	21 000	31 000
ML 7011	C 19	23 300	21 700	22 000	30 500
ML 71912	C 16	10 400	8 700	18 000	29 500
ML 7012	C 19	24 400	24 000	19 000	28 500
ML 71913	C 17	17 600	18 400	19 000	30 500
ML 7013	C 20	25 500	26 000	18 000	27 000
ML 71914	C 19	25 000	26 000	17 000	27 000
ML 7014	C 22	34 000	34 500	16 500	25 000
ML 71915	C 20	26 000	28 000	16 500	26 000
ML 7015	C 23	34 500	36 000	15 500	23 750
ML 71916	C 21	27 000	30 000	15 500	24 500
ML 7016	C 25	44 000	44 500	14 000	21 500
ML 71917	C 23	31 500	35 000	14 500	22 500
ML 7017	C 26	46 000	49 000	13 500	20 500
ML 71918	C 23	32 500	37 000	13 500	21 000
ML 7018	C 28	52 000	56 000	12 500	19 100
ML 71919	C 24	33 000	38 000	12 700	20 000
ML 7019	C 28	53 000	59 000	12 000	18 400
ML 71920	C 26	42 500	49 000	11 700	18 500
ML 7020	C 29	54 000	61 000	11 500	18 000
ML 7021	C 31	65 000	72 000	10 500	16 500
ML 71922	C 28	44 500	53 000	10 500	17 000
ML 7022	C 33	72 000	81 000	10 000	15 800
ML 71924	C 30	52 000	64 000	9 500	15 500
ML 7024	C 34	75 000	88 000	9 000	14 000
ML 71926	C 33	64 000	79 000	8 500	14 000
ML 7026	C 39	97 000	115 000	8 000	12 500

Series H	a	Basic load values in N		Limit speed in rpm	
		Dynamic C	Static Co	Grease	Oil
ML 71900	H 7	1 360	645	94 000	125 000
ML 7000	H 8	1 950	870	82 500	110 000
ML 71901	H 7	1 410	670	82 500	110 000
ML 7001	H 9	2 180	1 050	75 000	100 000
ML 71902	H 9	1 930	980	67 500	90 000
ML 7002	H 10	3 300	1 630	62 500	83 000
ML 71903	H 9	2 060	1 110	61 500	82 000
ML 7003	H 11	3 600	1 820	55 500	74 000
ML 71904	H 11	3 700	1 970	51 000	68 000
ML 7004	H 13	6 300	3 400	47 500	63 000
ML 71905	H 12	4 100	2 400	43 000	57 000
ML 7005	H 14	7 100	4 050	40 000	53 000
ML 71906	H 13	4 400	2 850	37 500	50 000
ML 7006	H 16	7 800	4 900	34 500	46 000
ML 71907	H 15	4 800	3 400	32 500	43 000
ML 7007	H 18	10 000	6 350	30 000	40 000
ML 71908	H 18	6 550	4 650	28 500	38 000
ML 7008	H 20	10 500	7 100	27 000	36 000
ML 71909	H 19	6 950	5 250	25 500	34 000
ML 7009	H 22	10 300	7 200	24 000	32 000
ML 71910	H 20	7 150	5 650	24 000	32 000
ML 7010	H 23	11 100	8 200	22 500	30 000
ML 71911	H 22	9 600	7 700	18 000	28 500
ML 7011	H 26	22 000	20 600	19 000	27 000
ML 71912	H 24	9 800	8 200	17 500	26 500
ML 7012	H 27	23 000	22 600	17 000	25 500
ML 71913	H 25	16 600	17 200	17 500	26 000
ML 7013	H 28	23 900	24 400	16 000	24 500
ML 71914	H 28	23 700	24 300	15 000	23 500
ML 7014	H 31	32 000	32 500	15 000	21 800
ML 71915	H 29	24 600	26 000	14 000	21 700
ML 7015	H 32	32 500	34 000	13 500	21 000
ML 71916	H 30	25 500	28 000	13 700	21 000
ML 7016	H 35	41 500	42 500	12 500	19 000
ML 71917	H 33	29 500	32 500	12 500	20 000
ML 7017	H 36	43 500	46 000	11 500	18 500
ML 71918	H 34	30 500	34 500	11 700	18 700
ML 7018	H 39	49 000	53 000	10 500	17 200
ML 71919	H 35	31 000	35 500	11 000	17 700
ML 7019	H 40	50 000	55 000	10 000	16 500
ML 71920	H 38	40 000	45 500	10 500	16 700
ML 7020	H 41	51 000	57 000	9 500	15 900
ML 7021	H 44	61 000	68 000	9 000	14 900
ML 71922	H 41	42 000	50 000	9 300	14 700
ML 7022	H 47	68 000	76 000	8 500	13 900
ML 71924	H 44	49 000	60 000	8 600	13 500
ML 7024	H 49	70 000	82 000	8 000	12 500
ML 71926	H 48	60 000	73 000	7 500	11 500
ML 7026	H 55	92 000	108 000	7 000	10 500

machine





# MachLine®: ranges

## High Speed and Sealed - ML & MLE

### Preload, axial and radial rigidity of DU DB DF arrangements

Symbol	Deflection constant	Preload (N)			Axial rigidity (N/μm)			Radial rigidity (N/μm)		
		7	8	9	7	8	9	7	8	9
	K (1)									
ML 71900 C	2,58	7	21	45	12	18	25	58	83	105
ML 7000 C	2,33	10	30	60	12	19	26	61	87	108
ML 71900 H	1,25	11	35	70	25	37	49	54	37	98
ML 7000 H	1,14	16	50	100	26	39	51	57	82	103
ML 71901 C	2,31	7	22	45	12	19	26	61	89	110
ML 7001 C	2,19	11	35	70	15	22	30	70	102	127
ML 71901 H	1,12	12	35	70	26	39	51	58	83	103
ML 7001 H	1,06	18	55	110	30	45	59	66	95	119
ML 71902 C	2,18	10	30	60	15	23	31	75	107	133
ML 7002 C	2,06	17	50	100	18	27	36	88	125	155
ML 71902 H	1,05	16	50	100	32	48	64	70	102	127
ML 7002 H	1,00	30	80	160	39	55	72	85	117	146
ML 71903 C	2,08	11	35	65	17	27	34	84	122	148
ML 7003 C	1,87	19	55	110	20	31	41	101	142	176
ML 71903 H	1,00	17	50	100	35	62	67	78	110	137
ML 7003 H	0,91	30	90	180	42	63	82	94	134	167
ML 71904 C	1,79	20	60	120	21	33	44	107	152	189
ML 7004 C	1,65	35	100	200	27	40	54	132	185	230
ML 71904 H	0,87	30	90	180	44	66	85	98	140	175
ML 7004 H	0,81	50	160	320	54	82	106	119	174	217
ML 71905 C	1,64	22	65	130	25	38	51	124	176	219
ML 7005 C	1,50	35	110	220	30	47	63	151	218	271
ML 71905 H	0,80	35	100	200	52	76	99	116	163	203
ML 7005 H	0,74	60	180	360	65	96	125	144	206	257
ML 71906 C	1,59	23	70	140	28	43	57	139	199	248
ML 7006 C	1,43	40	120	250	35	54	73	176	251	316
ML 71906 H	0,77	35	110	220	58	87	112	128	186	232
ML 7006 H	0,70	65	200	390	74	111	143	165	238	295
ML 71907 C	1,45	25	80	150	32	50	64	160	233	284
ML 7007 C	1,30	50	160	320	40	62	82	198	288	359
ML 71907 H	0,70	40	120	240	67	99	129	149	214	267
ML 7007 H	0,63	80	250	500	83	125	162	185	268	335
ML 71908 C	1,29	35	100	210	37	55	75	185	260	329
ML 7008 C	1,25	55	160	330	44	65	88	218	308	387
ML 71908 H	0,63	55	160	330	77	113	148	172	243	307
ML 7008 H	0,61	90	260	520	92	135	175	205	290	362
ML 71909 C	1,20	35	110	220	40	61	81	200	290	361
ML 7009 C	1,22	55	160	330	44	65	88	218	308	387
ML 71909 H	0,59	60	170	350	86	124	162	191	268	338
ML 7009 H	0,60	90	260	520	92	135	175	205	290	362
ML 71910 C	1,13	40	110	230	44	64	86	219	303	383
ML 7010 C	1,14	60	180	350	49	74	98	245	349	431
ML 71910 H	0,55	60	180	360	90	132	171	200	287	357
ML 7010 H	0,56	90	280	560	100	150	194	224	324	404
ML 71911 C	1,06	50	150	300	50	75	99	252	357	443
ML 7011 C	1,15	73	233	470	50	78	104	254	369	460
ML 71911 H	0,59	80	240	480	104	154	199	225	331	414
ML 7011 H	0,64	120	368	740	107	160	207	239	344	430
ML 71912 C	1,01	50	160	310	52	80	104	269	381	473
ML 7012 C	1,08	78	252	508	55	85	113	275	401	500
ML 71912 H	0,57	80	240	490	109	161	209	241	354	442
ML 7012 H	0,60	130	395	800	117	173	225	260	373	468



Symbol	Deflection constant K (1)	Preload (N)			Axial rigidity (N/μm)			Radial rigidity (N/μm)		
		7	8	9	7	8	9	7	8	9
ML 71913 C	1.03	62	185	370	53	81	107	268	382	475
ML 7013 C	1.03	85	271	546	59	92	122	298	434	541
ML 71913 H	0.57	88	288	576	108	164	212	240	354	442
ML 7013 H	0.57	140	430	860	126	188	243	281	405	506
ML 71914 C	1.04	92	265	530	61	91	121	306	431	536
ML 7014 C	1.03	115	360	720	66	102	135	332	480	598
ML 71914 H	0.57	130	265	820	123	185	239	274	399	498
ML 7014 H	0.57	190	573	1160	141	208	271	313	449	563
ML 71915 C	0.98	98	282	564	65	98	129	329	462	575
ML 7015 C	0.99	120	378	754	69	106	141	346	502	624
ML 71915 H	0.54	138	442	884	132	199	257	294	430	537
ML 7015 H	0.55	199	590	1200	147	216	281	327	466	585
ML 71916 C	0.94	104	300	600	70	104	138	351	494	615
ML 7016 C	1.00	151	475	950	74	114	152	372	539	670
ML 71916 H	0.52	148	470	940	141	213	275	315	459	574
ML 7016 H	0.56	252	750	1500	158	233	302	352	502	627
ML 71917 C	0.90	123	352	704	75	111	147	374	526	655
ML 7017 C	0.94	163	517	1030	80	124	165	404	586	728
ML 71917 H	0.52	174	550	1100	150	226	292	336	488	610
ML 7017 H	0.52	270	810	1620	171	253	327	381	545	681
ML 71918 C	0.89	130	374	748	79	118	157	399	561	698
ML 7018 C	0.92	184	570	1160	85	131	175	430	620	776
ML 71918 H	0.50	185	588	1176	160	242	312	358	522	652
ML 7018 H	0.51	315	925	1880	184	270	352	410	583	732
ML 71919 C	0.87	134	385	770	82	122	162	412	579	720
ML 7019 C	0.90	195	608	1220	89	138	183	450	650	810
ML 71919 H	0.48	191	603	1206	166	249	322	370	538	672
ML 7019 H	0.50	326	960	1950	191	281	366	426	606	760
ML 71920 C	0.87	172	495	980	88	132	174	443	623	773
ML 7020 C	0.88	200	628	1260	93	143	190	466	674	839
ML 71920 H	0.48	246	770	1540	178	267	346	398	578	722
ML 7020 H	0.49	336	1005	2010	198	293	379	441	631	788
ML 7021 C	0.89	238	760	1520	97	151	200	489	711	885
ML 7021 H	0.49	398	1200	2400	208	308	398	462	663	828
ML 71922 C	0.83	190	540	1080	97	145	192	489	685	852
ML 7022 C	0.87	265	810	1650	103	156	209	516	741	927
ML 71922 H	0.46	270	846	1692	196	295	381	439	637	795
ML 7022 H	0.48	448	1330	2700	220	324	422	490	699	877
ML 71924 C	0.79	226	645	1290	108	161	213	542	760	946
ML 7024 C	0.83	287	885	1820	111	170	228	558	803	1008
ML 71924 H	0.44	322	1000	2000	218	326	421	487	704	880
ML 7024 H	0.46	480	1440	2880	237	351	454	528	756	944
ML 71926 C	0.78	278	790	1580	116	172	228	582	816	1015
ML 7026 C	0.81	375	1170	2400	124	191	256	626	905	1135
ML 71926 H	0.43	400	1240	2480	235	351	454	524	759	948
ML 7026 H	0.45	630	1880	3800	267	393	511	594	848	1062

(1) Axial deflection constant in μm (daN)<sup>-2/3</sup> 7 = light preload 8 = medium preload 9 = heavy preload



# Precision self-locking nuts

*It is highly recommended that precision self-locking nuts are used whenever MachLine bearings are installed. They can be used to preload a bearing assembly and ensure the preload is maintained over time. When used with large axial loads, the assembly can be reliably positioned to last.*

## Features

- High strength steel (1,000 N/mm<sup>2</sup>) throughout the range, protected by finish rolling (apart from back face and threads).
- Squareness < 2 µm between back face / bore.
- Metric thread with tolerance 5H (as per ISO 965/1).
- Narrow or wide series.
- Locking via blind holes or slots.
- Nuts locked with 2 or 4 bronze inserts.



## Installation precautions

As with bearings, wait until the last moment to remove nuts from packaging to avoid contamination risks. Place them on the rolled face. Once the nut has been tightened with a wrench (DIN 1810A and DIN 1810B), tighten the insert fastening screws with an Allen key (4 insert series: tighten gradually in a cross formation).

**You are advised to replace nuts each time bearings are replaced.**



*SNR offers a full range of wrenches which are solid, secure and easy to use. The 5 dimensions of our wrenches are sufficient to replace the equivalent of 15 conventional fixed models. For more information, visit: [www.snr-bearings.com](http://www.snr-bearings.com) or contact your SNR technician.*

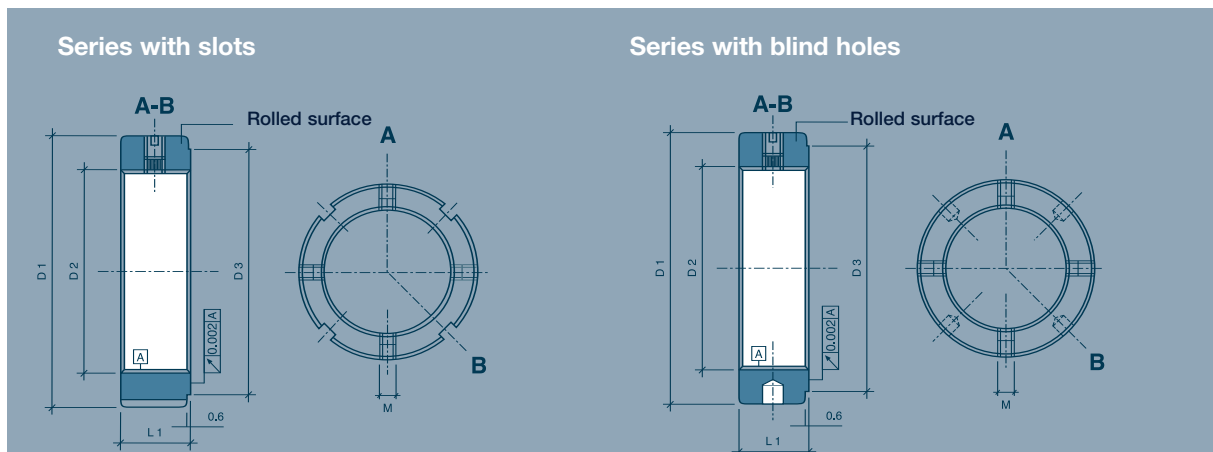

Series	Number of inserts	Slots	Blind holes
Narrow	2	B	TB
	4	BR	TBR
Wide	2	BP	TBP
	4	BPR	TBPR

## Dimensions and part numbers

### Nuts type B and TB

Threads	P/N		Weight	Dimensions				Locking screw	Nuts		
				D1	L1	D3	M		Mbl	Far	Ma
-	-	-	kg	mm	mm	mm	mm	N.m	kN	N.m	N.m
M8 x 0,75	<b>B 8/0.75</b>	-	0,01	16	8	11	M4	1	27	4	26
M12 x 1	<b>B 12/1</b>	-	0,015	22	8	18	M4	1	47	8	31
M15 x 1	<b>B 15/1</b>	-	0,02	25	8	21	M4	1	65	10	32
M17 x 1	<b>B 17/1</b>	-	0,03	28	10	24	M5	3	100	15	32
M20 x 1	<b>B 20/1</b>	<b>TB 20/1</b>	0,04	32	10	28	M5	4-5	140	18	39
M20 x 1,5	<b>B 20/1,5</b>	<b>TB 20/1,5</b>	0,04	32	10	28	M5	4-5	126	18	39
M25 x 1,5	<b>B 25</b>	<b>TB 25</b>	0,06	38	12	33	M5	4-5	198	25	56
M30 x 1,5	<b>B 30</b>	<b>TB 30</b>	0,08	45	12	40	M5	4-5	240	32	63
M35 x 1,5	<b>B 35</b>	<b>TB 35</b>	0,11	52	12	47	M5	4-5	263	40	72
M40 x 1,5	<b>B 40</b>	<b>TB 40</b>	0,15	58	14	52	M6	8-10	290	55	97
M45 x 1,5	<b>B 45</b>	<b>TB 45</b>	0,18	65	14	59	M6	8-10	322	65	115
M50 x 1,5	<b>B 50</b>	<b>TB 50</b>	0,20	70	14	64	M6	8-10	351	85	132
M55 x 2	<b>B 55</b>	<b>TB 55</b>	0,25	75	16	68	M8	16-18	378	95	148
M60 x 2	<b>B 60</b>	<b>TB 60</b>	0,27	80	16	73	M8	16-18	405	100	186
M65 x 2	<b>B 65</b>	<b>TB 65</b>	0,28	85	16	78	M8	16-18	431	120	196
M70 x 2	<b>B 70</b>	<b>TB 70</b>	0,38	92	18	85	M8	16-18	468	130	228
M75 x 2	<b>B 75</b>	<b>TB 75</b>	0,42	98	18	90	M8	16-18	497	150	255
M80 x 2	<b>B 80</b>	<b>TB 80</b>	0,49	105	18	95	M8	16-18	527	160	291
M85 x 2	<b>B 85</b>	<b>TB 85</b>	0,52	110	18	100	M8	16-18	558	190	315
M90 x 2	<b>B 90</b>	<b>TB 90</b>	0,75	120	20	110	M8	16-18	603	200	369
M95 x 2	<b>B 95</b>	<b>TB 95</b>	0,78	125	20	115	M8	16-18	637	220	391
M100 x 2	<b>B 100</b>	<b>TB 100</b>	0,82	130	20	120	M8	16-18	688	250	432

### Nuts type BP and TBP

Threads	P/N		Weight	Dimensions				Locking screw	Nuts		
				D1	L1	D3	M		Mbl	Far	Ma
-	-	-	kg	mm	mm	mm	mm	N.m	kN	N.m	N.m
M20 x 1	<b>BP 20/1</b>	<b>TBP 20/1</b>	0,12	38	20	28	M5	4-5	255	18	39
M20 x 1,5	<b>BP 20/1,5</b>	<b>TBP 20/1,5</b>	0,12	38	20	28	M5	4-5	225	18	39
M25 x 1,5	<b>BP 25</b>	<b>TBP 25</b>	0,17	45	20	33	M6	8-10	405	25	56
M30 x 1,5	<b>BP 30</b>	<b>TBP 30</b>	0,24	52	22	40	M6	8-10	491	32	63
M35 x 1,5	<b>BP 35</b>	<b>TBP 35</b>	0,28	58	22	47	M6	8-10	560	40	72
M40 x 1,5	<b>BP 40</b>	<b>TBP 40</b>	0,29	62	22	52	M8	16-18	585	55	97
M45 x 1,5	<b>BP 45</b>	<b>TBP 45</b>	0,37	68	24	59	M8	16-18	641	65	115
M50 x 1,5	<b>BP 50</b>	<b>TBP 50</b>	0,46	75	25	64	M8	16-18	706	85	132
M55 x 2	<b>BP 55</b>	<b>TBP 55</b>	0,92	88	32	68	M8	16-18	940	95	148
M60 x 2	<b>BP 60</b>	<b>TBP 60</b>	1,14	98	32	73	M8	16-18	1 070	100	186
M65 x 2	<b>BP 65</b>	<b>TBP 65</b>	1,29	105	32	78	M8	16-18	1 155	120	196
M70 x 2	<b>BP 70</b>	<b>TBP 70</b>	1,49	110	35	85	M8	16-18	1 230	130	228
M75 x 2	<b>BP 75</b>	<b>TBP 75</b>	2,25	125	38	90	M10	30-32	1 300	150	255
M80 x 2	<b>BP 80</b>	<b>TBP 80</b>	2,97	140	38	95	M10	30-32	1 420	160	291
M85 x 2	<b>BP 85</b>	<b>TBP 85</b>	3,44	150	38	100	M10	30-32	1 510	190	315
M90 x 2	<b>BP 90</b>	<b>TBP 90</b>	3,59	155	38	110	M10	30-32	1 596	200	369
M95 x 2	<b>BP 95</b>	<b>TBP 95</b>	3,73	160	38	115	M10	30-32	1 656	220	391
M100 x 2	<b>BP 100</b>	<b>TBP 100</b>	3,70	160	40	120	M10	30-32	1 780	250	432

**Far:** Axial breaking load (corresponds to thread failure). In operation, a nut should support less than 75 % of axial breaking load **Far** specified for this nut / **Ma:** Nut installation torque / **Md:** Nut untightening torque (installed with corresponding torques **Ma** and **Mbl**) / **Mbl:** Insert tightening torque / **D1:** Outside diameter / **D3:** Back face diameter / **L1:** Width



# Precision self-locking nuts

## Dimensions and part numbers

### Nuts type BR and TBR

Threads	P/N		Weight	Dimensions				Locking screw	Nuts		
	D2			D1	L1	D3	M		Mbl	Far	Ma
			kg	mm	mm	mm	mm	N.m	kN	N.m	N.m
M25 x 1,5	<b>BR 25</b>	<b>TBR 25</b>	0,06	38	12	33	M5	3-4	198	25	85
M30 x 1,5	<b>BR 30</b>	<b>TBR 30</b>	0,08	45	12	40	M5	3-4	240	32	96
M35 x 1,5	<b>BR 35</b>	<b>TBR 35</b>	0,11	52	12	47	M5	3-4	263	40	107
M40 x 1,5	<b>BR 40</b>	<b>TBR 40</b>	0,15	58	14	52	M6	6-8	290	55	127
M45 x 1,5	<b>BR 45</b>	<b>TBR 45</b>	0,18	65	14	59	M6	6-8	322	65	149
M50 x 1,5	<b>BR 50</b>	<b>TBR 50</b>	0,20	70	14	64	M6	6-8	351	85	180
M55 x 2	<b>BR 55</b>	<b>TBR 55</b>	0,25	75	16	68	M8	12-14	378	95	206
M60 x 2	<b>BR 60</b>	<b>TBR 60</b>	0,27	80	16	73	M8	12-14	405	100	255
M65 x 2	<b>BR 65</b>	<b>TBR 65</b>	0,28	85	16	78	M8	12-14	431	120	277
M70 x 2	<b>BR 70</b>	<b>TBR 70</b>	0,38	92	18	85	M8	12-14	468	130	304
M75 x 2	<b>BR 75</b>	<b>TBR 75</b>	0,42	98	18	90	M8	12-14	497	150	357
M80 x 2	<b>BR 80</b>	<b>TBR 80</b>	0,49	105	18	95	M8	12-14	527	160	396
M85 x 2	<b>BR 85</b>	<b>TBR 85</b>	0,52	110	18	100	M8	12-14	558	190	444
M90 x 2	<b>BR 90</b>	<b>TBR 90</b>	0,75	120	20	110	M8	12-14	603	200	501
M95 x 2	<b>BR 95</b>	<b>TBR 95</b>	0,78	125	20	115	M8	12-14	637	220	550
M100 x 2	<b>BR 100</b>	<b>TBR 100</b>	0,82	130	20	120	M8	12-14	688	250	603

### Nuts type BPR and TBPR

Threads	P/N		Weight	Dimensions				Locking screw	Nuts		
	D2			D1	L1	D3	M		Mbl	Far	Ma
			kg	mm	mm	mm	mm	N.m	kN	N.m	N.m
M20 x 1	<b>BPR 20/1</b>	<b>TBPR 20/1</b>	0,12	38	20	28	M5	3-4	255	18	56
M20 x 1,5	<b>BPR 20/1,5</b>	<b>TBPR 20/1,5</b>	0,12	38	20	28	M5	3-4	225	18	56
M25 x 1,5	<b>BPR 25</b>	<b>TBPR 25</b>	0,17	45	20	33	M6	6-8	405	25	85
M30 x 1,5	<b>BPR 30</b>	<b>TBPR 30</b>	0,24	52	22	40	M6	6-8	491	32	96
M35 x 1,5	<b>BPR 35</b>	<b>TBPR 35</b>	0,28	58	22	47	M6	6-8	560	40	107
M40 x 1,5	<b>BPR 40</b>	<b>TBPR 40</b>	0,29	62	22	52	M8	12-14	585	55	127
M45 x 1,5	<b>BPR 45</b>	<b>TBPR 45</b>	0,37	68	24	59	M8	12-14	641	65	149
M50 x 1,5	<b>BPR 50</b>	<b>TBPR 50</b>	0,46	75	25	64	M8	12-14	706	85	180
M55 x 2	<b>BPR 55</b>	<b>TBPR 55</b>	0,92	88	32	68	M8	12-14	940	95	206
M60 x 2	<b>BPR 60</b>	<b>TBPR 60</b>	1,14	98	32	73	M8	12-14	1 070	100	255
M65 x 2	<b>BPR 65</b>	<b>TBPR 65</b>	1,29	105	32	78	M8	12-14	1 155	120	277
M70 x 2	<b>BPR 70</b>	<b>TBPR 70</b>	1,49	110	35	85	M8	12-14	1 230	130	304
M75 x 2	<b>BPR 75</b>	<b>TBPR 75</b>	2,25	125	38	90	M10	24-26	1 300	150	357
M80 x 2	<b>BPR 80</b>	<b>TBPR 80</b>	2,97	140	38	95	M10	24-26	1 420	160	396
M85 x 2	<b>BPR 85</b>	<b>TBPR 85</b>	3,44	150	38	100	M10	24-26	1 510	190	444
M90 x 2	<b>BPR 90</b>	<b>TBPR 90</b>	3,59	155	38	110	M10	24-26	1 596	200	501
M95 x 2	<b>BPR 95</b>	<b>TBPR 95</b>	3,73	160	38	115	M10	24-26	1 656	220	550
M100 x 2	<b>BPR 100</b>	<b>TBPR 100</b>	3,70	160	40	120	M10	24-26	1 780	250	603

**Far**: Axial breaking load (corresponds to thread failure). In operation, a nut should support less than 75 % of axial breaking load **Far** specified for this nut / **Ma**: Nut installation torque / **Md**: Nut untightening torque (installed with corresponding torques **Ma** and **Mbl**) / **Mbl**: Insert tightening torque / **D1**: Outside diameter / **D3**: Back face diameter / **L1**: Width





# Summary of ranges: find the appropriate SNR solution

## MachLine range

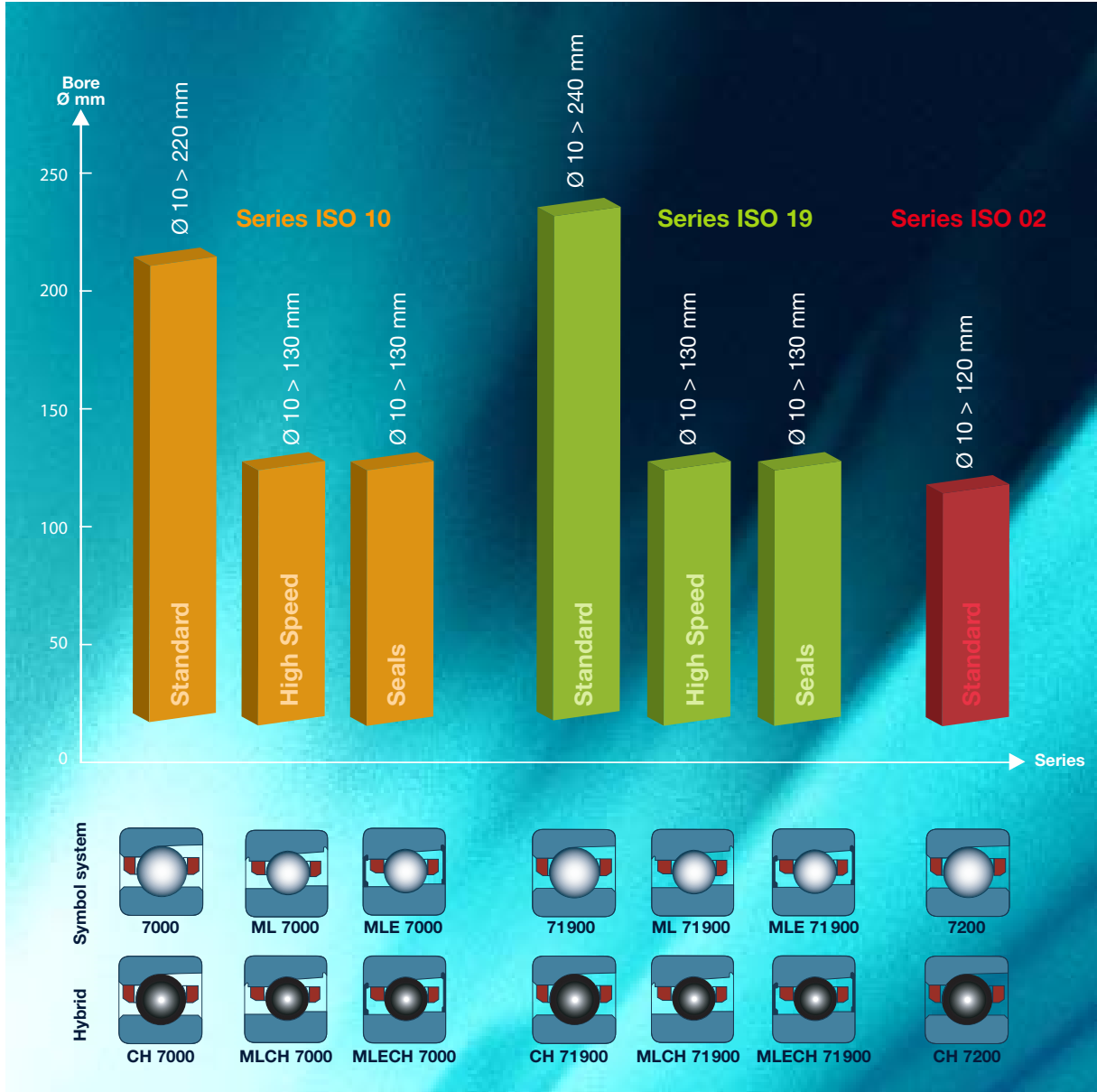

## Range of precision nuts

Series	Number of inserts	Slots	Blind holes	Application	Bore
Narrow	2	B	-	Normal use	8 to 100
		-	TB		20 to 100
Wide	4	BR	TBR	Medium load: maximum flatness required	25 to 100
		BP	TBP	High loads	20 to 100
Wide	4	BPR	TBPR	Very high loads: maximum flatness required	20 to 100

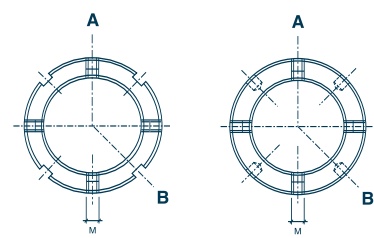

Specific nuts can be manufactured on request (diameter, number of inserts, etc.)



# Tolerances and precision classes

## Ring tolerance

Spindle precision in rotation has a direct influence on machining precision. SNR manufactures bea-

rings in very high precision class P4S and super precision class ISO 2.

		Inner ring Tolerances in $\mu\text{m}$									
		Exclusive	6	10	18	30	50	80	120	150	180
Bore (d) in mm		Inclusive	10	18	30	50	80	120	150	180	250
Tolerances	Symbol (1)										
Tolerance on mean diameter	$\Delta \text{dmp}$	ISO 4	0	0	0	0	0	0	0	0	0
			-4	-4	-5	-6	-7	-8	-10	-10	-12
		ISO 2	0	0	0	0	0	0	0	0	
			-2,5	-2,5	-2,5	-2,5	-4	-5	-7	-7	-8
Roundness	Series 719 max. Vdp	ISO 4	4	4	5	6	7	8	10	10	12
		ISO 2	2,5	2,5	2,5	2,5	4	5	7	7	8
	Series 70-72	ISO 4	3	3	4	5	5	6	8	8	9
		ISO 2	2,5	2,5	2,5	2,5	4	5	7	7	8
Taper	max. Vdmp	ISO 4	2	2	2,5	3	3,5	4	5	5	6
		ISO 2	1,5	1,5	1,5	1,5	2	2,5	3,5	3,5	4
Radial run-out	max. $K_{ia}$	ISO 4	2,5	2,5	3	4	4	5	6	6	8
		ISO 2	1,5	1,5	2,5	2,5	2,5	2,5	2,5	5	5
Face run-out with respect to bore	max. $S_d$	ISO 4	3	3	4	4	5	5	6	6	7
		ISO 2	1,5	1,5	1,5	1,5	1,5	2,5	2,5	4	5
Raceway run-out with respect to face	max. $S_{ia}$	ISO 4	3	3	4	4	5	5	7	7	8
		ISO 2	1,5	1,5	2,5	2,5	2,5	2,5	2,5	5	5
Tolerance on bearing width	$\Delta B_s$	ISO 4	0	0	0	0	0	0	0	0	0
		ISO 2	-40	-80	-120	-120	-150	-200	-250	-250	-300
Alignment of faces	max. VBs	ISO 4	2,5	2,5	2,5	3	4	4	5	5	6
		ISO 2	1,5	1,5	1,5	1,5	1,5	2,5	2,5	4	5

(1) Symbols for tolerances comply with standard ISO 492

## Equivalence of precision standards

Quality	ISO	ABEC	DIN
High precision	4	7	P4
Very high precision P4S (SNR Standard)	2: dynamic 4: dimensional	9: dynamic 7: dimensional	P2: dynamic P4: dimensional
Super precision	2	9	P2

Tolerances		Symbol (1)	Outer ring Tolerances in $\mu\text{m}$										
			Exclusive	2,5	18	30	50	80	120	150	180	250	31
Outside diameter (D) in mm			Inclusive	18	30	50	80	120	150	180	250	315	400
Tolerance on mean diameter	$\Delta D_{mp}$	ISO 4	0 -4	0 -5	0 -6	0 -7	0 -8	0 -9	0 -10	0 -11	0 -13	0 -15	
		ISO 2	0 -2,5	0 -4	0 -4	0 -4	0 -5	0 -5	0 -7	0 -8	0 -8	0 -10	
Roundness	Series 719 max. VDp	ISO 4	4	5	6	7	8	9	10	11	13	15	
		ISO 2	2,5	4	4	4	5	5	7	8	8	10	
Roundness	Series 70-72	ISO 4	3	4	5	5	6	7	8	8	10	11	
		ISO 2	2,5	4	4	4	5	5	7	8	8	10	
Taper	max. VDmp	ISO 4	2	2,5	3	3,5	4	5	5	6	7	8	
		ISO 2	1,5	2	2	2	2,5	2,5	3,5	4	4	5	
Radial run-out	max. $K_{ea}$	ISO 4	3	4	5	5	6	7	8	10	11	13	
		ISO 2	1,5	2,5	2,5	4	5	5	5	7	7	8	
Face run-out with respect to bore	max. $S_D$	ISO 4	4	4	4	4	5	5	5	7	8	10	
		ISO 2	1,5	1,5	1,5	1,5	2,5	2,5	2,5	4	5	7	
Raceway run-out with respect to face	max. $S_{ea}$	ISO 4	5	5	5	5	6	7	8	10	10	13	
		ISO 2	1,5	2,5	2,5	4	5	5	5	7	7	8	
Tolerance on bearing width	$\Delta C_s$	ISO 4 ISO 2	Identical values to those of the bearing inner ring										
Alignment of faces	max. $VC_s$	ISO 4	2,5	2,5	2,5	3	4	5	5	7	7	8	
		ISO 2	1,5	1,5	1,5	1,5	2,5	2,5	2,5	4	5	7	

(1) Symbols for tolerances comply with standard ISO 492



# Tolerances and precision classes

## | Bearing seat tolerances

In order not to alter preloading or damage rotational accuracy, seats must be very close to bearing dimensions. In general, we recommend the fits specified below. When installing the bearings, we advise matching them with their seats to avoid assembling parts at the extremes of their tolerance limits, which can only lead to excessive clearance or tight fit.

### Tolerances in microns

Nominal diameter (mm)	Shaft			Housing					
	ISO4		ISO2	ISO4				ISO2	
				Fixed assembly		Floating assembly		Fixed assembly	Floating assembly
	h4 (1)	js4(2)	-	JS5(1)	K5(2)	H5(3)	Play (4)	JS4	-
10 to 18	0 -5	+3 -3	0 -4	- -	- -	- -	- -	- -	- -
> 18 to 30	0 -6	+3 -3	0 -4	+4 -4	+1 -8	+9 0	2 to 10	+3 -3	+8 +2
> 30 to 50	0 -7	+4 -4	0 -5	+5 -5	+2 -9	+11 0	3 to 11	+4 -4	+10 +2
> 50 to 80	0 -8	+4 -4	0 -5	+6 -6	+3 -10	+13 0	3 to 12	+4 -4	+11 +3
> 80 to 120	0 -10	+5 -5	0 -6	+7 -7	+2 -13	+15 0	5 to 15	+5 -5	+13 +3
> 120 to 180	0 -12	+6 -6	0 -8	+9 -9	+3 -15	+18 0	5 to 17	+6 -6	+16 +4
> 180 to 250	0 -14	+7 -7	0 -10	+10 -10	+2 -18	+20 0	7 to 22	+7 -7	+18 +4
> 250 to 315	- -	- -	- -	+11 -11	+3 -20	+23 0	7 to 27	+8 -8	+21 +5
> 315 to 400	- -	- -	- -	+12 -12	+3 -22	+25 0	7 to 30	+9 -9	+23 +5

(1) Light load  $C/P > 16$ , Medium load  $10 \leq C/P \leq 16$

(2) Heavy load  $C/P < 10$  or high speed applications (ML range)

(3) We recommend a tolerance, but the optimum fitting is obtained by matching the housing and bearings within the tolerance limits specified in column (4)

## Shape and position tolerances for shoulders and seats

Spindle performance (rotational accuracy, heat level) depends to a large extent on the manufacturing quality of seats and their shoulders. To meet targets,

these characteristics must be within the tolerances recommended by SNR.

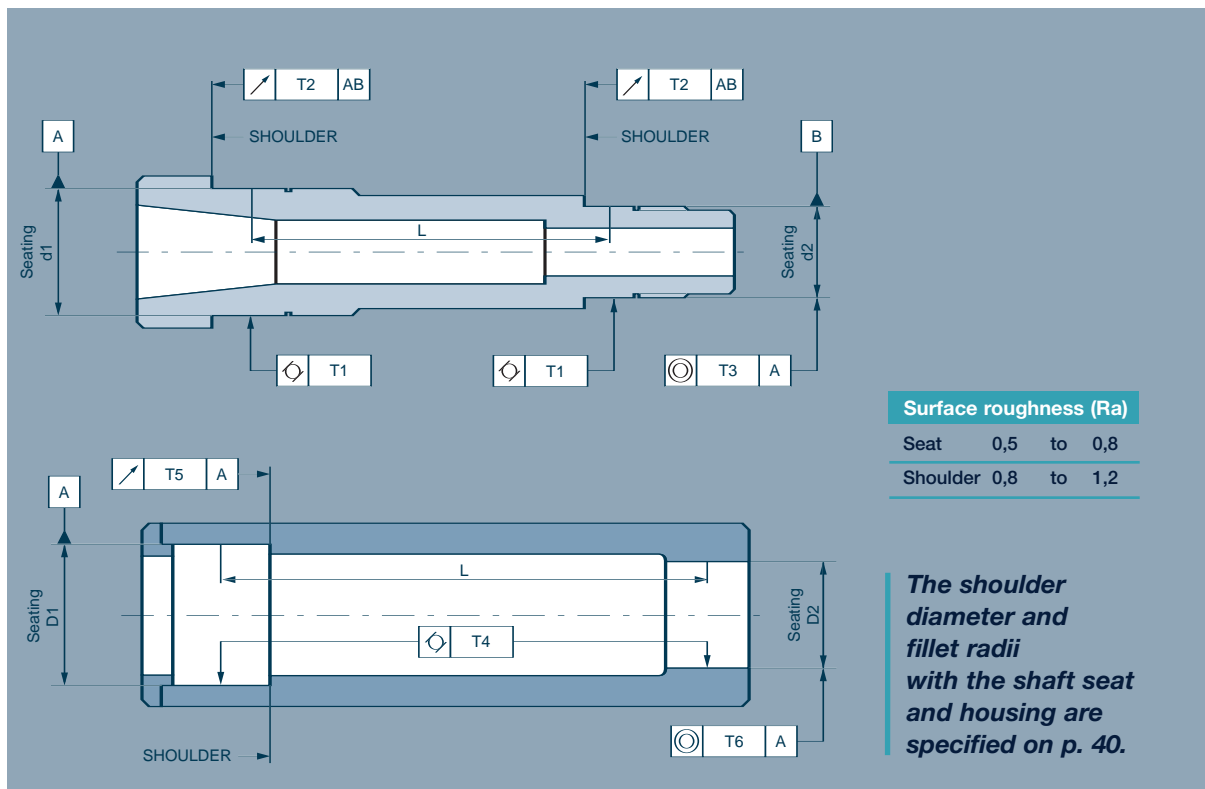

### Maximum tolerances in microns

Nominal diameter of seat	Shaft						Housing					
	T1		T2		T3		T4		T5		T6	
	ISO 4	ISO 2	ISO 4	ISO 2	ISO 4	ISO 2	ISO 4	ISO 2	ISO 4	ISO 2	ISO 4	ISO 2
10 to 18	1,5	1	2	1,2	0,013L <sup>(1)</sup>	0,008L <sup>(1)</sup>	-	-	-	-	-	-
> 18 to 30	2	1	2,5	1,5	0,013L <sup>(1)</sup>	0,008L <sup>(1)</sup>	2	1,5	2,5	1,5	0,015L <sup>(1)</sup>	0,010L <sup>(1)</sup>
> 30 to 50	2	1,5	2,5	1,5	0,013L <sup>(1)</sup>	0,008L <sup>(1)</sup>	2,5	1,5	2,5	1,5	0,015L <sup>(1)</sup>	0,010L <sup>(1)</sup>
> 50 to 80	2,5	1,5	3	2	0,013L <sup>(1)</sup>	0,008L <sup>(1)</sup>	3	2	3	2	0,015L <sup>(1)</sup>	0,010L <sup>(1)</sup>
> 80 to 120	3	2	4	2,5	0,025L <sup>(1)</sup>	0,013L <sup>(1)</sup>	3,5	2,5	4	2,5	0,030L <sup>(1)</sup>	0,015L <sup>(1)</sup>
> 120 to 180	3,5	2	5	3,5	0,025L <sup>(1)</sup>	0,013L <sup>(1)</sup>	4,5	3	5	3,5	0,030L <sup>(1)</sup>	0,015L <sup>(1)</sup>
> 180 to 250	4	2,5	7	4,5	0,025L <sup>(1)</sup>	0,013L <sup>(1)</sup>	5	3,5	7	4,5	0,030L <sup>(1)</sup>	0,015L <sup>(1)</sup>
> 250 to 315	-	-	-	-	-	-	6	4	8	6	0,030L <sup>(1)</sup>	0,015L <sup>(1)</sup>
> 315 to 400	-	-	-	-	-	-	6	4,5	9	7	0,030L <sup>(1)</sup>	0,015L <sup>(1)</sup>

(1) L = distance between bearing units in mm



# Tolerances and precision classes

## Component tolerances - spacers and clamping nuts

Rotational accuracy of the spindle also depends on manufacturing precision of spacers and nuts.

### Spacers

Spacers must be rigid enough to avoid any bending during tightening. They should be no longer than 200 mm. Tolerances for their alignment and length differences are specified below.

### Clamping nuts

Whether the nut is threaded or pressed on, its clamping face must be perpendicular to the bearing seat. The axial run-out tolerance of the face is specified below.

### Maximum tolerances in microns

Nominal bore of spacer or nominal diameter of bearing seat	Spacer				Nut	
	T2		Difference in length between L1 and L2		T2	
	ISO4	ISO2	ISO4	ISO2	ISO4	ISO2
10 to 18	2	1	2	1	5	3
> 18 to 30	2	1	2	1	6	4
> 30 to 50	2	1	2	1	7	4
> 50 to 80	2	1	3	2	8	5
> 80 to 120	3	2	3	2	10	6
> 120 to 180	3	2	4	3	12	8
> 180 to 250	4	3	5	4	14	10



# Maintenance and services

*Maintenance is a major issue, particularly for heavily used components such as bearings.*

*It has an influence on productivity, occupational health and safety, and the environment. Maintenance is a risk avoidance operation based most of all on human know-how. Our teams will talk you through their expertise over the course of this chapter ...*

- Storage 62
- Assembly 63-66
- Vibratory analysis 67
- Expert analysis, training 68



## Storage: rules to follow

*Every SNR bearing undergoes a specific packaging process in order to ensure its original qualities are maintained during storage. Spindle results in the long-term will be dependent on the precautions taken on installation.*

### SNR packaging process and bearing protection

- Assembly is carried out in a dust-free air-conditioned environment.
- High covering power anti-oxidant protective oil is applied in a controlled atmosphere. This protection is compatible with all currently-used lubricants.
- The final protective elements are a heat-sealed protective bag and a packing box.

### Normal storage conditions

- General cleanliness.
- Free of dust and corrosive atmospheric conditions.
- Recommended temperature: 18° to 20 °C.
- Maximum relative humidity: 65 %. For exceptional climatic conditions, specific packaging will be necessary (e.g.: specific packaging for tropical countries).
- Do not store on wooden shelves.
- Keep at least 30 cm from ground, walls and heating pipework.
- Avoid exposure to the sun.
- Store boxes flat and do not stack to high.
- Lay out boxes so bearing part number is visible without handling.



### Storage time

Thanks to their standard unit packaging, SNR bearings can have long storage times and the normal storage conditions.

The packaging must not be opened, altered or damaged.



# Installation: rules to follow

## General installation precautions

Spindle should be assembled in clean, well-lit area away from manufacturing sites, in order to avoid risk of contamination.

Do not remove bearings from their box until they are to be installed. Do not wash bearings under any circumstances.



*The bearing must be stored in its original packaging and not opened until the time of use.*

## Pre-installation checks

Dimensions and tolerances of components making up the spindle must first be checked (see pages 58 to 60). All components must be carefully washed and dried before installation.

## Bearing installation

Bearing seats must be coated with an anti-corrosive product. SNR recommends the use of an assembly paste.

*Products used for bearing protection are compatible with all SNR-recommended lubricants.*

## Selection of outside diameter and bore dimensions

To obtain as uniform as possible preload and an external load distributed evenly as possible between all bearings in an arrangement, it is recommended that there should be almost identical interferences or clearances between these bearings and their supports (shaft and housing).

Outside diameter and bore dimensions are marked on the package and dimension selection need not involve removing bearing from box.

# Installation: rules to follow

## Lubrication

- Grease must be injected using a graduated syringe.
- SNR can supply pre-greased bearings (suffix D or sealed bearings MLE).
- For oil-based lubrication, inject some oil of the

same type as used in the system. This precaution will avoid dry start-up which could seriously damage bearings.

**Define appropriate lubrication method: see page 25.**

**For grease lubrication, follow recommended volumes (page 26).**

## Bearing positioning

- **Universal bearings and pairs of universal bearings:** Pay attention to bearing position according to contact angles to obtain the desired assembly type. For MachLine ML and MLE, use the individual « V » marked on the outer rings.

### - Arrangement of matched bearings:

- An arrangement is inseparable and must not be mixed.
- Find the « V » marked on the outside diameter of bearings in order to correctly position bearings in the arrangement.
- Orientate the tip of « V » in the direction of preferential axial thrust A.

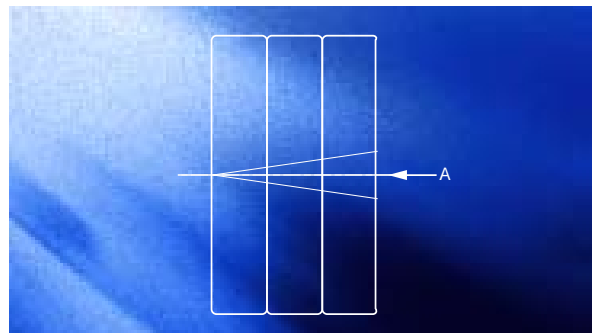
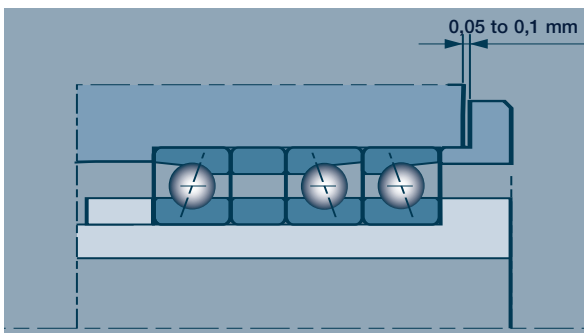

## | Installation

- **Heat-assisted fitting (expansion) is preferable to any other method.** If this is impossible, apply the pressure to the entire parameter of the ring to be fitted. Do not exert any pressure on the other ring because balls must never transmit a force-fitting load.
- **Fitting by impact (e.g. with a hammer) is strictly prohibited.**



## | Oppose defects

- Shaft and/or housing run-out with respect to bearing radial round out.
- Spacers.
- Line up inner ring high points.

## | Tightening

- Tighten sideplate screws gradually in a cross formation to avoid misaligning the outer ring in the housing.
- Measure radial run-out of spindle nose before and after locking to check that the shaft has not been deformed by tightening. The values should be identical.

## | Balancing

After fitting bearings on shaft, it must be balanced to eliminate any unbalance which could affect correct spindle operation at high speed.

# Installation: rules to follow

## Run-in procedure

The run-in procedure has a considerable influence on the accuracy of spindle rotation and its service life. The procedure must be carried out in steps, depending on the spindle type and temperature rise. The rotation speed of the first step must be at a low enough N.Dm (of the order of  $10^5$ ) to be certain that the lubrication film is established. Run-in time at each step depends on the time required for bearing temperature to stabilise. As soon as the temperature is stabilised, move on to next step.

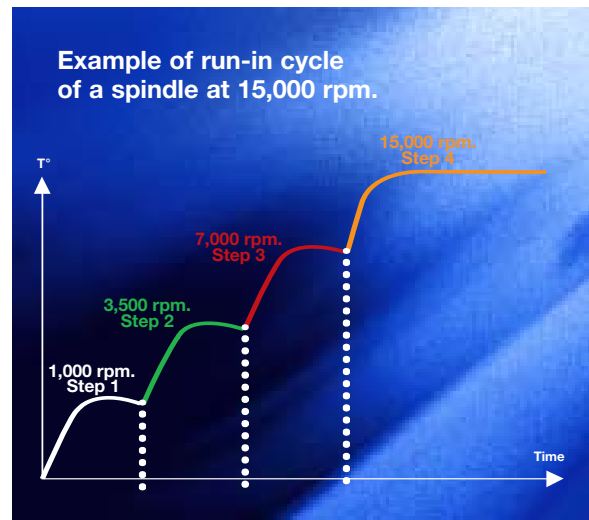

## Characteristic failures

**Spalling failures due to material fatigue are extremely rare on MachLine spindle bearings.**

Spindle failures are more characterized by deviation of a certain number of factors observed and measured on the manufactured components, which indicate the requirement for spindle maintenance.

These factors are:

- Difficulties in maintaining dimensions.
- Increasing geometrical defects such as circularity or radial run-out.
- Poor surface finish.
- Unusual surface condition (chatter marks, vibration, etc.).
- Abnormal noises in operation.

In 70 % of cases failures are linked to lubrication problems and in 10 % of cases, linked to the sealing system or a sudden impact between the part and the tool which can cause damage to spindle and bearings.

***The bearing itself is rarely the cause of premature failure.***

# Vibratory analysis: an objective, all-round approach

*The whole mechanical environment must be taken into account for maintenance, as interactions between the bearing and other components give useful indications. This all-round approach, based on experience with many different applications, is nevertheless indissociable from objective figures and data, which guarantee neutral diagnostics. This is why SNR uses specialised partners.*

## | SNR and 01dB Metravib

Our partnership with this company provides you with specialist expert services in vibratory analysis. Fixed or portable monitoring systems can be designed and implemented to enable predictive maintenance of machine tools.

Our vibratory analysis services can help you design:

- **Monitoring methods,**
- **Monitoring periodicity,**
- **The organisational structure to use,**
- **Results layout and technical-economical studies.**

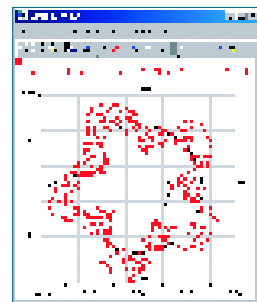
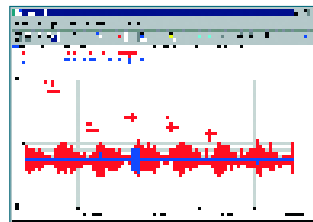
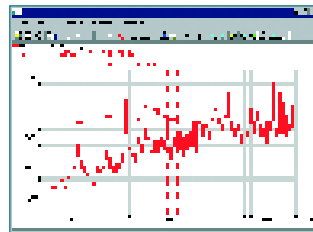

*These services are fitted to each individual case. They may involve work or longer-term contracts, and we will never offer more than you need.*

*For more information, contact your SNR technician.*

machline





## Expert analysis, training: passing on our know-how

### | Expert analysis: investigate the causes

Our experts are at your service for prototype installations or post-operation bearing analysis.

For an optimum analysis, it is vital to:

- remove bearings extremely carefully (it is difficult to distinguish any defects due to working conditions from those due to careless removal).
- send bearings as they are (do not wash).

- record bearing position within the spindle.
- inform our services of the spindle installation operating conditions: speed, load, lubrication and an overall drawing of the spindle.

### | Characteristic frequencies

In order to monitor spindles in operation, SNR can provide characteristic frequencies for spindle bearing components on request.

This information is also available in the e-catalogue:

[www.snr-bearings.com/catalogue](http://www.snr-bearings.com/catalogue)

Nevertheless, due to the low deviation of recorded signals, interpreting results is delicate and must be carried out by an expert.

### | Training: customized services

SNR offers a full training program, written and delivered by our engineers and machine tool spindle bearing experts.

This training course is designed for sales teams wishing to improve their product knowledge or technical design teams, manufacturing and maintenance technicians. It aims to:

- Fully introduce the MachLine range,
- Help in selecting the technical solutions appropriate for your applications,
- Introduce spindle calculations,
- Present the key installation operation phases for a spindle bearing.

### | SNR is open 24 hours a day, 7 days a week.



Our catalogs are available on line for checking product availability in real-time and making on-line procurement and urgent orders. It's simple and easy and available 24 hours a day, 7 days a week. Go to [www.snr-bearings.com/catalogue](http://www.snr-bearings.com/catalogue) then click on "Catalogue Industry".



*Go straight to [www.snr-bearings.com](http://www.snr-bearings.com) and fill in the on-line form, or directly contact your usual SNR representative to take advantage of these services.*

# SNR: aeronautical precision made available for machine tools

SNR is a partner in major aeronautical and space programs such as the Airbus A380 or Ariane 5 and it has now transferred the experience and knowledge acquired in these fields to the area of machine tools. The MachLine range offers high precision bearings suited for extreme speed, sealing and reliability requirements.

